

TECHNICAL SPECIFICATION

COLOURS

COUNTER TOP - GLASS



WHITE, LACOBEL

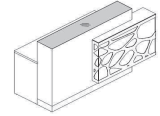

BODY



67 WHITE PASTEL

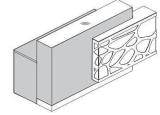

FRONT - METAL



15 HIGH GLOSS WHITE

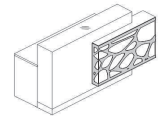

FRONT - PLEXIGLASS

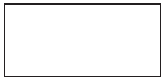

PLEXIGLASS WHITE

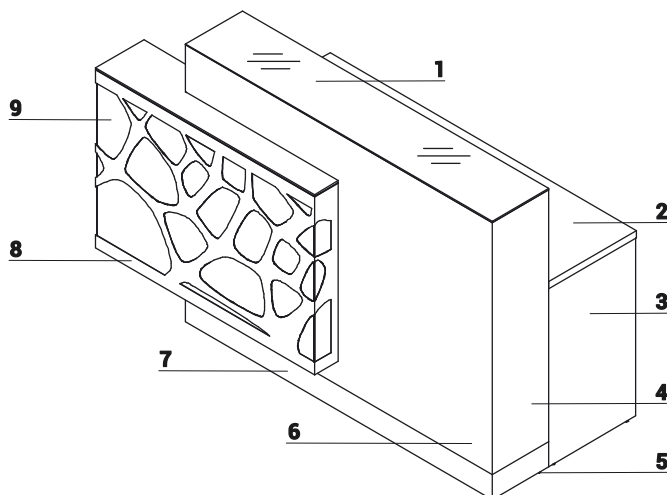
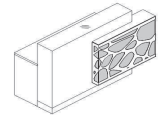

1. **Glass top** - glass LACOBEL 4mm
2. **Worktop** - MFC 28mm, PVC edge
3. **Front** - powder coated steel and plexiglas
4. **Light source** - RGBW LED, remote control
5. **Low side panel** - MFC 28mm, PVC edge
6. **Kick plate** - HPL - brushed aluminium
7. **Body** - MFC 18mm+ HPL - mat
8. **Front** - MFC 28mm + HPL - mat 0,8mm, PVC edge
9. **Leveling** - 5mm range

TECHNICAL SPECIFICATION

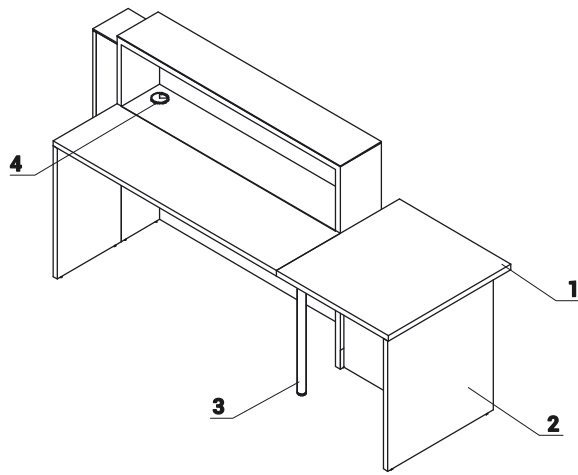

- 1. **Worktop** - MFC 28mm, PVC edge
- 2. **Low side panel** - MFC 28mm, PVC edge
- 3. **Supporting leg NE41**- required for connecting the tops
- 4. **Cable grommets** - Ø80mm

DIMENSIONS

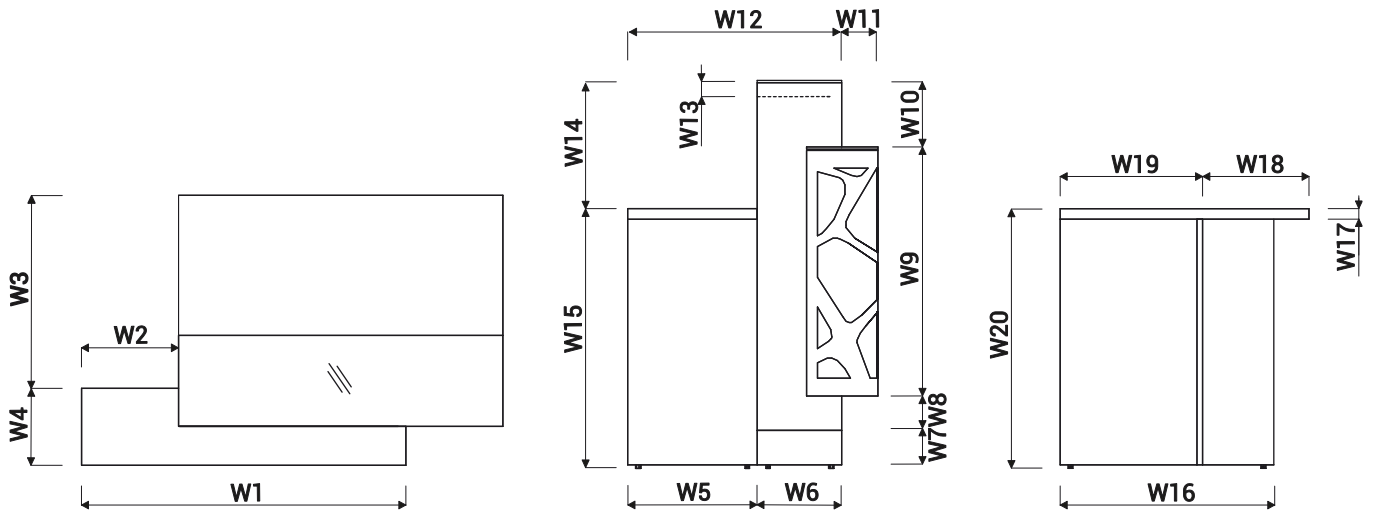

W1 - 1000mm | W2 - 300mm | W3 - 550mm | W4 - 222mm | W5 - 400mm | W6 - 260mm | W7 - 100mm | W8 - 97mm | W9 - 705mm | W10 - 184mm | W11 - 110mm | W12 - 660mm | W13 - 34mm | W14 - 365mm | W15 - 740mm | W16 - 660mm | W17 - 28mm | W18 - 318mm | W19 - 452mm | W20 - 740mm

RECEPTION DESKS SYSTEMS

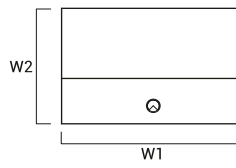
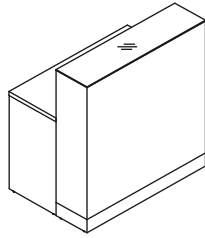

INDEX SYMBOL	DIMENSIONS [mm]						kg	m3	pcs		COMPONENTS
	W <sub>1</sub>	W <sub>2</sub>	D <sub>1</sub>	D <sub>2</sub>	H						
<b>LOG10G</b>	1000	660	-	-	1105		50.0	0.582	2		LOG10B+LOG10K
<b>LOG14G</b>	1400	660	-	-	1105		55.0	0.815	2		LOG14B+LOG14K

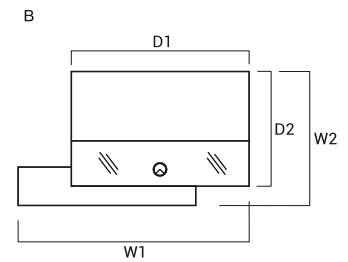
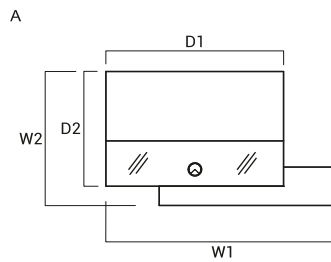
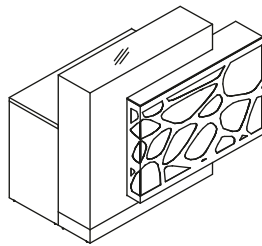

INDEX SYMBOL	DIMENSIONS [mm]						kg	m3	pcs		COMPONENTS
	W <sub>1</sub>	W <sub>2</sub>	D <sub>1</sub>	D <sub>2</sub>	H						
<b>A LOG11LG</b>	1300	770	1000	660	1105		75.5	0.740	4		LOG10B+LOG10K+LOG01L
<b>B LOG11PG</b>	1300	770	1000	660	1105		75.5	0.740	4		LOG10B+LOG10K+LOG01P

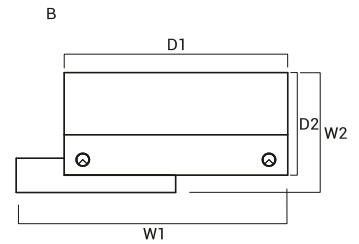
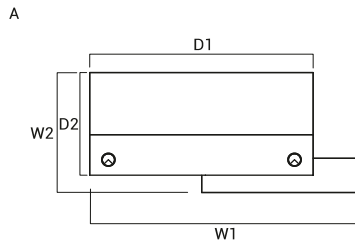
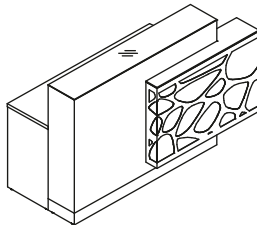

INDEX SYMBOL	DIMENSIONS [mm]						kg	m3	pcs		COMPONENTS
	W <sub>1</sub>	W <sub>2</sub>	D <sub>1</sub>	D <sub>2</sub>	H						
<b>A LOG12LG</b>	1700	770	1400	660	1105		80.5	0.973	4		LOG14B+LOG14K+LOG01L
<b>B LOG12PG</b>	1700	770	1400	660	1105		80.5	0.973	4		LOG14B+LOG14K+LOG01P

DESCRIPTION

- NET WEIGHT

VOLUME

NUMBER OF PACKAGES

RECEPTION DESKS SYSTEMS

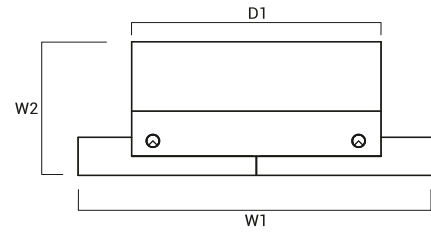
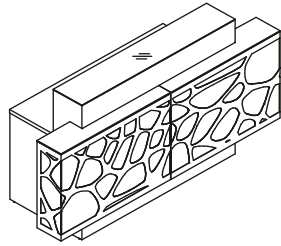

INDEX SYMBOL	DIMENSIONS [mm]										COMPONENTS
	W <sub>1</sub>	W <sub>2</sub>	D <sub>1</sub>	D <sub>2</sub>	H						
<b>LOG13G</b>	2000	770	1400	-	1105		106.0	1.132	6		LOG14B+LOG14K+LOG01L+LOG01P

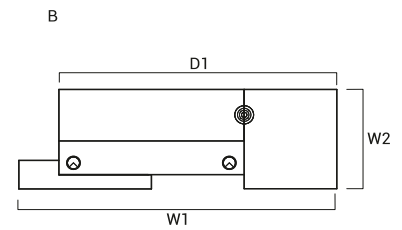
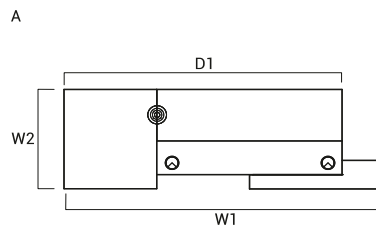
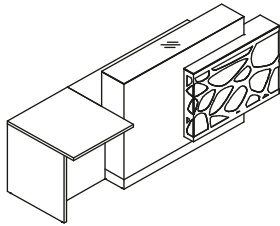

INDEX SYMBOL	DIMENSIONS [mm]										COMPONENTS
	W <sub>1</sub>	W <sub>2</sub>	D <sub>1</sub>	D <sub>2</sub>	H						
<b>A LOG14PLG</b>	2400	770	2100	-	1105		93.8	1.007	6		LOG01L+LOG14K+LOG14B+LOG07+NE41L
<b>B LOG14PPG</b>	2400	770	2100	-	1105		93.8	1.007	6		LOG07+LOG14B+LOG14K+LOG01P+NE41L

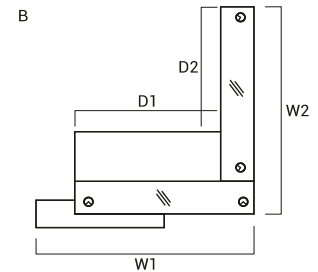
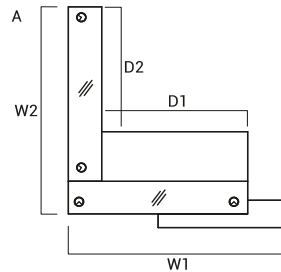
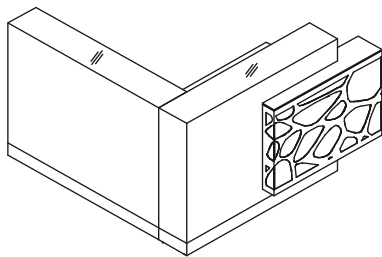

INDEX SYMBOL	DIMENSIONS [mm]										COMPONENTS
	W <sub>1</sub>	W <sub>2</sub>	D <sub>1</sub>	D <sub>2</sub>	H						
<b>A LOG16LG</b>	1700	1660	1140	1000	1105		120.5	1.297	5		LOG01L+2xLOG14K+LOG11B
<b>B LOG16PG</b>	1700	1770	-	-	1105		120.5	1.297	5		2xLOG14K+LOG11B+LOG01P

DESCRIPTION

- NET WEIGHT

VOLUME

NUMBER OF PACKAGES

RECEPTION DESKS SYSTEMS

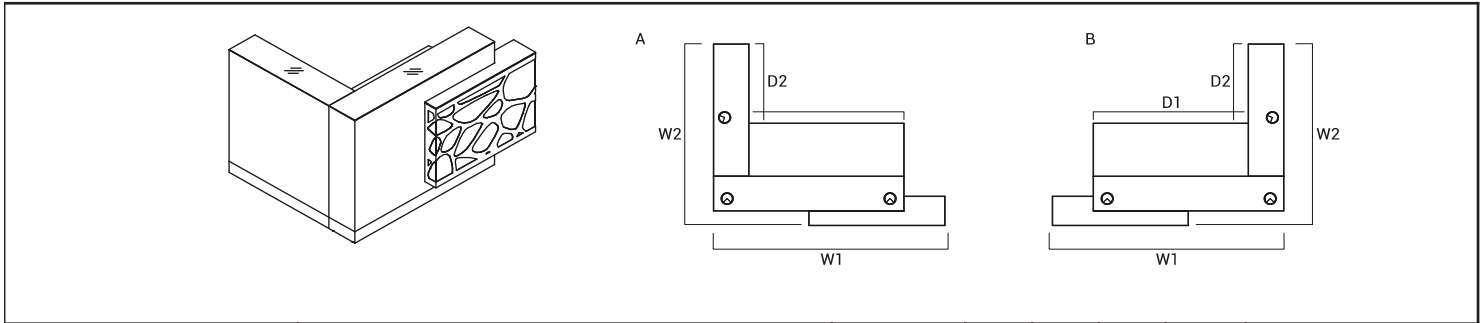

INDEX SYMBOL	DIMENSIONS [mm]						kg	m3	pcs	COMPONENTS
	W <sub>1</sub>	W <sub>2</sub>	D <sub>1</sub>	D <sub>2</sub>	H					
A <b>LOG18LG</b>	1700	1370	1140	600	1105		115.5	1.182	5	LOG01L+LOG14K+LOG11B+LOG10K
B <b>LOG18PG</b>	1700	1370	-	-	1105		115.5	1.182	5	LOG10K+LOG11B+LOG14K+LOG01P

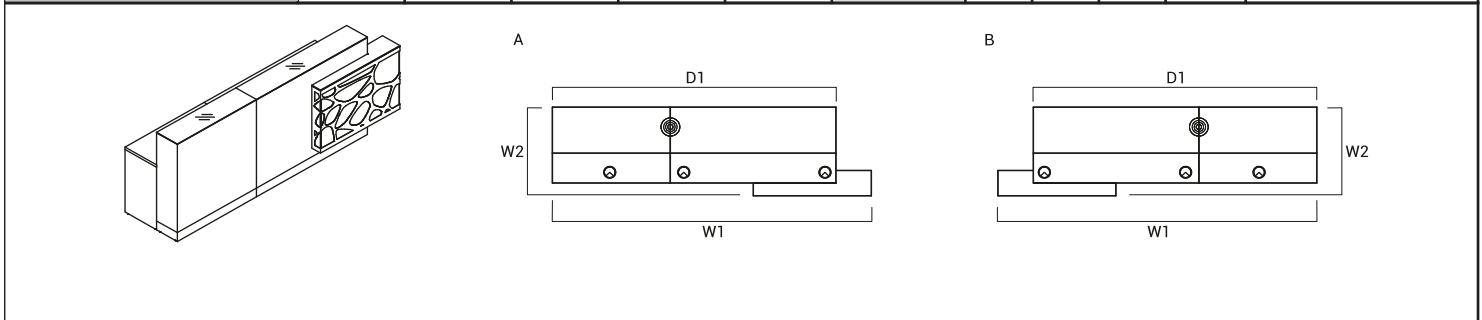

INDEX SYMBOL	DIMENSIONS [mm]						kg	m3	pcs	COMPONENTS
	W <sub>1</sub>	W <sub>2</sub>	D <sub>1</sub>	D <sub>2</sub>	H					
A <b>LOG19LG</b>	2700	770	2400	-	1105		131.8	1.557	7	LOG01L+LOG14K+LOG10K+LOG14B+LOG10B+NE41L
B <b>LOG19PG</b>	2700	770	2400	-	1105		131.8	1.557	7	LOG10B+LOG14B+LOG10K+LOG14K+LOG01P+NE41L

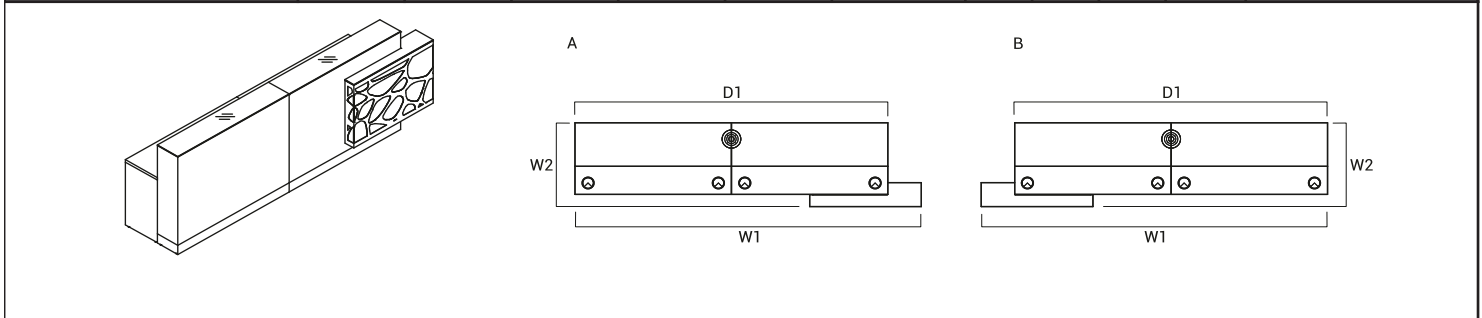

INDEX SYMBOL	DIMENSIONS [mm]						kg	m3	pcs	COMPONENTS
	W <sub>1</sub>	W <sub>2</sub>	D <sub>1</sub>	D <sub>2</sub>	H					
A <b>LOG20LG</b>	3100	770	2800	-	1105		136.8	1.790	7	LOG01L+2xLOG14K+2xLOG14B+NE41L
B <b>LOG20PG</b>	3100	770	2800	-	1105		136.8	1.790	7	2xLOG14B+2xLOG14K+LOG01P+NE41L

DESCRIPTION

- NET WEIGHT

VOLUME

NUMBER OF PACKAGES

RECEPTION DESKS SYSTEMS

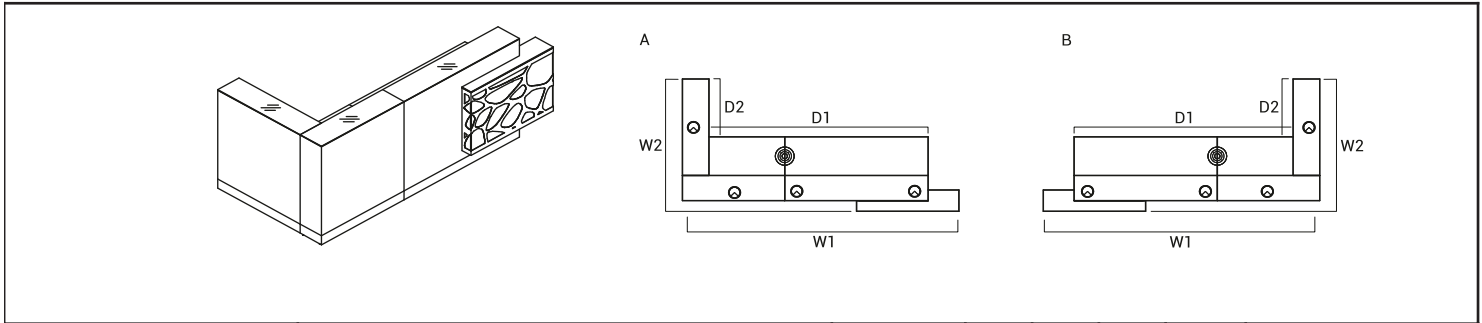

INDEX SYMBOL	DIMENSIONS [mm]						kg	m3	pcs	COMPONENTS
	W <sub>1</sub>	W <sub>2</sub>	D <sub>1</sub>	D <sub>2</sub>	H					
A <b>LOG21LG</b>	2700	1370	2140	600	1105		162.8	1.555	8	LOG01L+LOG14K+2xLOG10K+LOG14B+LOG08B+NE41L
B <b>LOG21PG</b>	2700	1370	2140	600	1105		162.8	1.555	8	2xLOG10K+LOG08B+LOG14B+LOG14K+LOG01P+NE41L

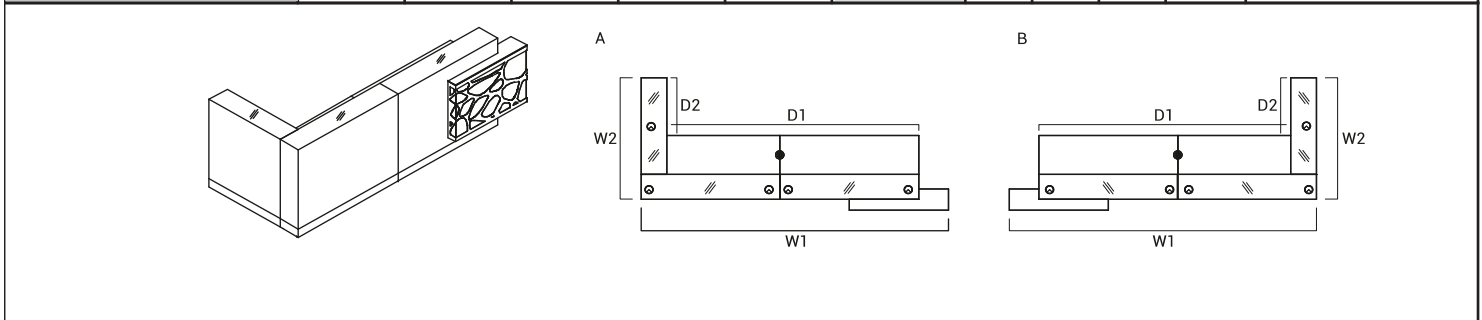

INDEX SYMBOL	DIMENSIONS [mm]						kg	m3	pcs	COMPONENTS
	W <sub>1</sub>	W <sub>2</sub>	D <sub>1</sub>	D <sub>2</sub>	H					
A <b>LOG22LG</b>	3100	1370	2540	600	1105		171.8	1.999	8	LOG01L+2xLOG14K+LOG14B+LOG11B+LOG10K+NE41L
B <b>LOG22PG</b>	3100	1370	2540	600	1105		171.8	1.999	8	LOG10K+LOG11B+LOG14B+2xLOG14K+LOG01P+NE41L

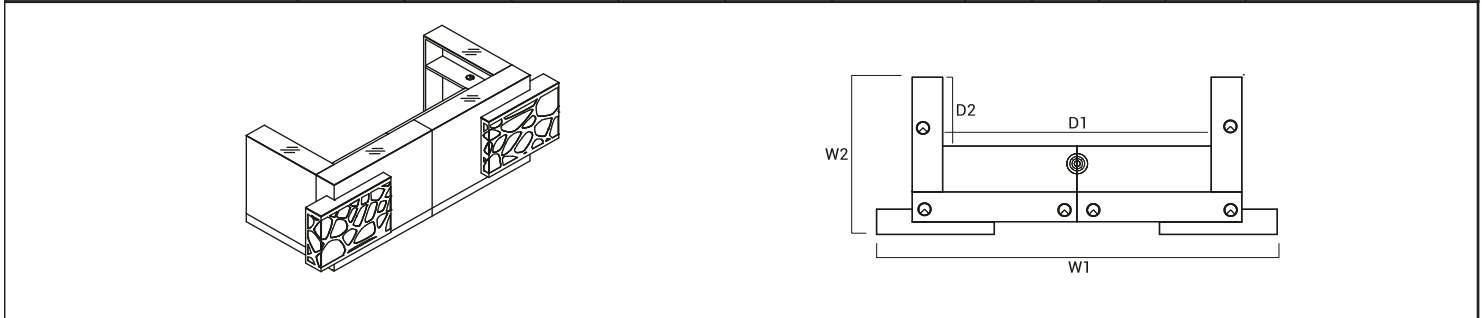

INDEX SYMBOL	DIMENSIONS [mm]						kg	m3	pcs	COMPONENTS
	W <sub>1</sub>	W <sub>2</sub>	D <sub>1</sub>	D <sub>2</sub>	H					
<b>LOG23G</b>	3400	1370	2280	600	1105		232.3	2.366	11	2xLOG10K+2xLOG11B+2xLOG14K+LOG01L+LOG01P+NE41L

DESCRIPTION

- NET WEIGHT

VOLUME

NUMBER OF PACKAGES

RECEPTION DESKS SYSTEMS

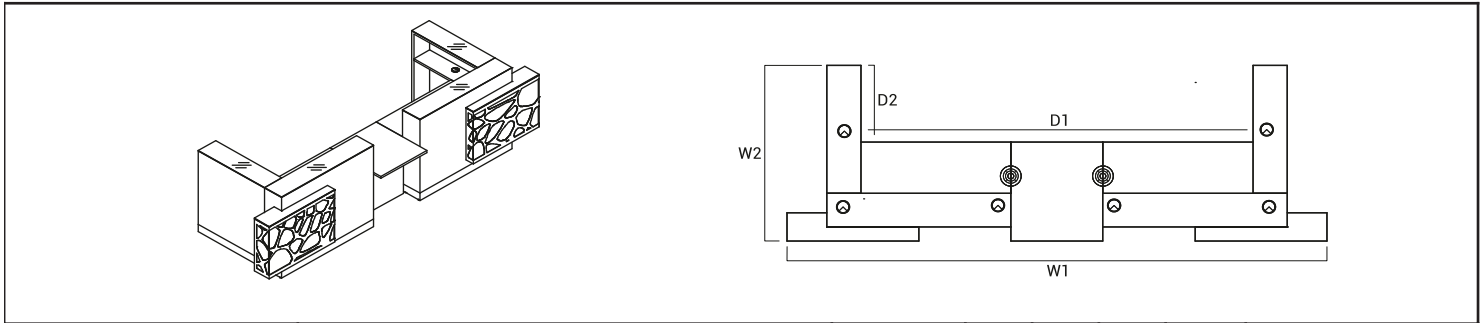

INDEX SYMBOL	DIMENSIONS [mm]						kg	m3	pcs	COMPONENTS
	W1	W2	D1	D2	H					
<b>LOG24G</b>	4100	1370	-	-	1105		245.6	2.401	13	2xLOG10K+2xLOG14K+2xLOG11B +LOG07+LOG01L+LOG01P +2xNE41L

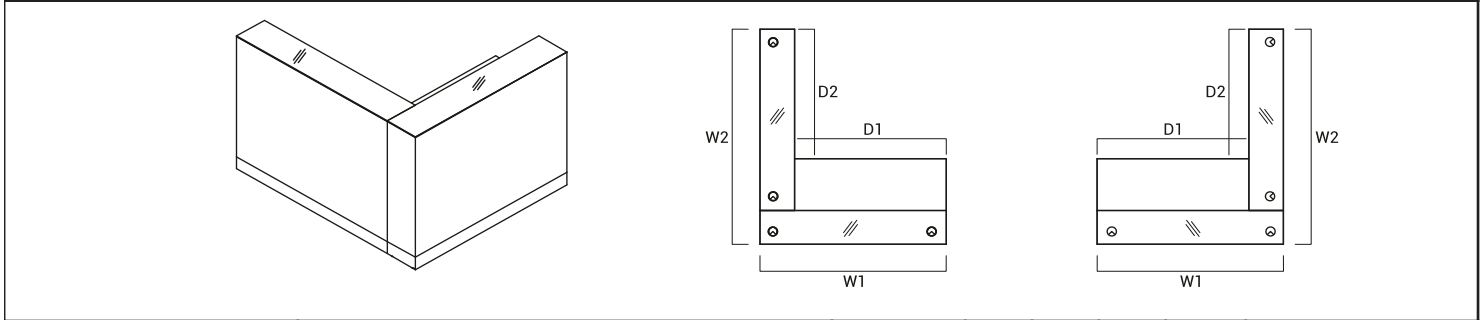

INDEX SYMBOL	DIMENSIONS [mm]						kg	m3	pcs	COMPONENTS
	W1	W2	D1	D2	H					
<b>LOG15</b>	1400	1660	-	-	1105		95.0	1.138	3	2xLOG14K+LOG11B

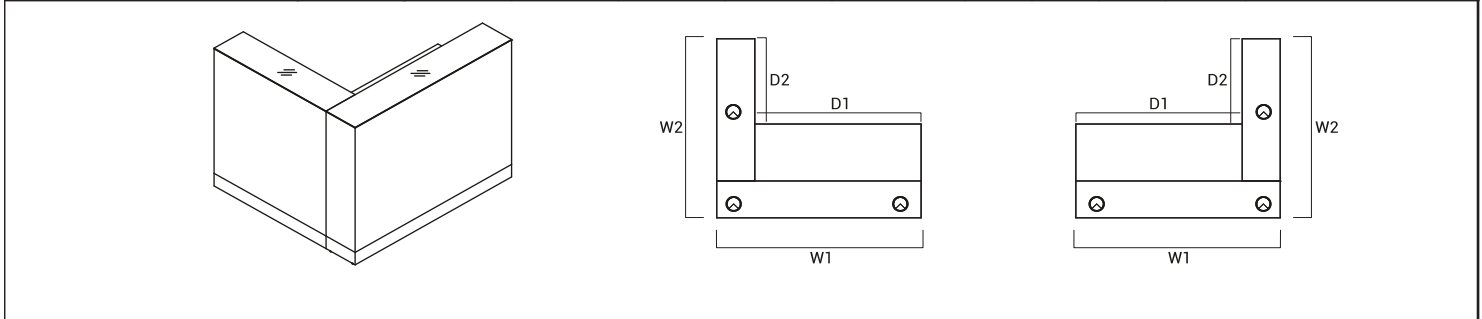

INDEX SYMBOL	DIMENSIONS [mm]						kg	m3	pcs	COMPONENTS
	W1	W2	D1	D2	H					
<b>LOG17</b>	1400	1260	-	-	1105		90.0	1.024	3	LOG11B+LOG14K+LOG10K

DESCRIPTION

- NET WEIGHT

VOLUME

NUMBER OF PACKAGES

RECEPTION DESKS SYSTEMS

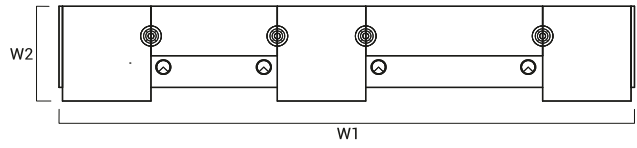
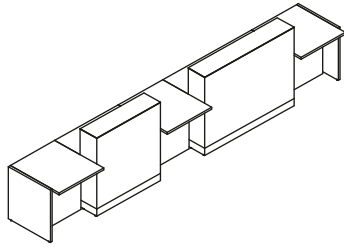

INDEX SYMBOL	DIMENSIONS [mm]										COMPONENTS
	W <sub>1</sub>	W <sub>2</sub>	D <sub>1</sub>	D <sub>2</sub>	H						
<b>LOG25</b>	4556	770	-	-	1105		146.2	1.501	11		3xLOG07+LOG14B+LOG14K +LOG10B+LOG10K+4xNE41L

DESCRIPTION

- NET WEIGHT

VOLUME

NUMBER OF PACKAGES



PRODUCT ILLUSTRATION	DIMENSIONS [mm]			INDEX SYMBOL						COMPONENTS
	WIDTH	DEPTH	HEIGHT			kg	m3	pcs		

COMPOSITION ELEMENTS

	728	770	740	LOG07		13.3	0.034	2		universal element
	1000	220	710	LOG01P		25.5	0.158	2		right
	1000	220	710	LOG01L		25.5	0.158	2		left
	1000	260	1105	LOG10K		35.0	0.286	1		
	1400	260	1105	LOG14K		40.0	0.400	1		
	740	400	28	LOG08B		11.0	0.008	1		
	1000	400	740	LOG10B		15.0	0.296	1		
	1140	400	740	LOG11B		15.0	0.337	1		
	1400	400	740	LOG14B		15.0	0.414	1		
	40	40	712	NE41L		1.5	0.002	1		round profile leg

DESCRIPTION

- NET WEIGHT

VOLUME

NUMBER OF PACKAGES