



FINISHES GUIDE
EDUCATION - AUGUST 2017

Contents



Polypropylene Finishes

4-9

- Postura+ Chair, Stool, High Chair & Task Chair
- Plaza
- Integra
- Grazie (inc. Learn2)
- Intellect Wave (inc. Learn2)
- Maestro
- Matrix
- Perry
- Ruckus
- Strive (inc. Learn2)
- Sway Lounge Chair, Ottoman & Table
- Torsion on the Go!
- Doni



Metal Finishes

10-11

- Powdercoat
- Metallic & Chrome



Writing Tablets

12-15

- Dimensions
- Laminate
- Polypropylene



Sway2 Table

16

- Laminate



Upholstery Options

17-19

- Fabric Bands
- Postura+ Fabric & Vinyl (closest match suggestions)



This finishes guide contains all of KI Europe's standard options for the full portfolio of education furniture.

KI reserves the right to make changes in design and construction or discontinue products without prior notice. This finishes guide may contain discontinued options, and displayed finishes may vary slightly from final product.

Please get in touch with your KI sales manager for the most up to date finishes, product options and non-standard finishes requests.

KI (UK) Ltd
New Fetter Place
8-10 New Fetter Lane
London, EC4A 1AZ
T: 020 7405 7082
E: education@kieurope.com
W: www.kieurope.com/education

Polypropylene Finishes

Postura+ (Chair, Stools, High Chairs & Task Chairs)

Postura+ Chair

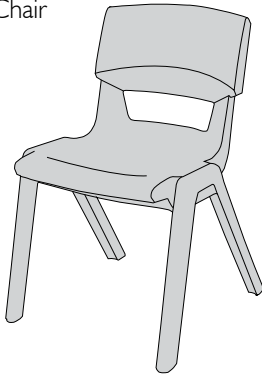

Postura+ Stool



Postura+ High Chair



Postura+ Task Chair



Sugar Plum



Grape Crush †



Pink Candy †



Powder Blue †



Aqua Blue †



Ink Blue * †



Forest Green * †

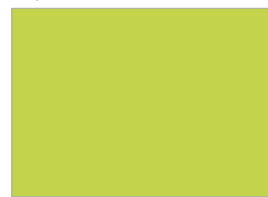

Lime Zest †

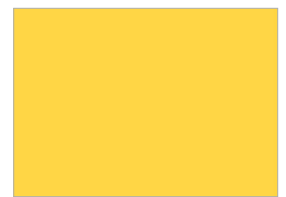

Sun Yellow * †



Tangerine Fizz †



Poppy Red * †



Almond White

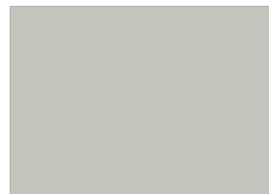

Ash Grey †



Iron Grey



Slate Grey †

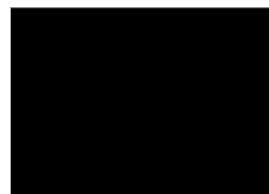

Jet Black



Custom Colours

All colours available for 430mm (size 5) and 460mm (size 6) chairs, high chairs, stools & task chairs.

* Colour selection for 260mm chairs (size 1)

† Colour selection for 310mm, 350mm & 380mm chairs (size 2, 3 & 4)

Custom colours based on a Pantone reference with a minimum order of 100 units

Polypropylene Finishes

Plaza



Poppy Red



Persimmon



Apple Green



Topaz Blue



Cottonwood



Dolphin



Flannel

Plaza

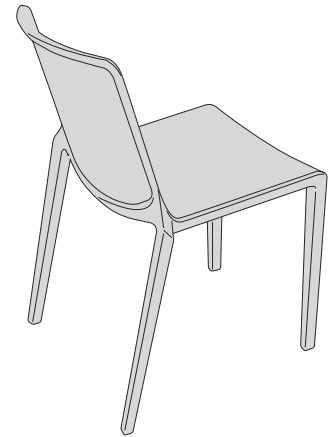

Integra



Ink Blue



Ash Grey

Integra

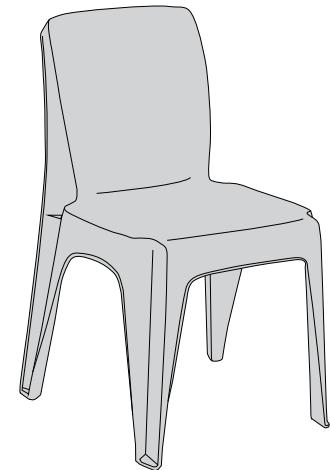

Polypropylene Finishes

Grazie



Intellect Wave

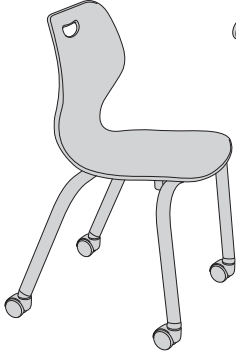

Maestro



Matrix

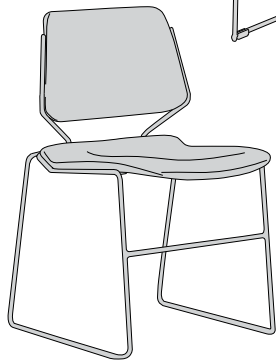

Perry

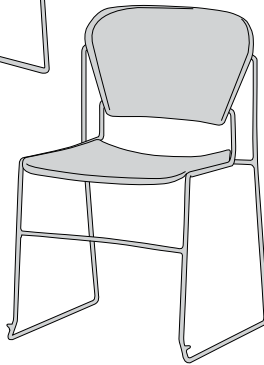

Ruckus

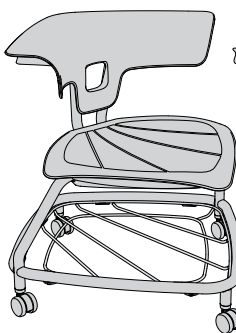

Strive

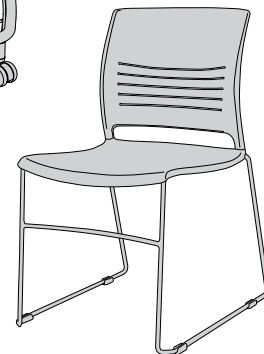

Standard Solid Colours



Black *



Chocolate



Misty Brown



Flannel *



Blue Grey



Warm Grey

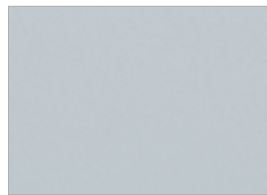

Cool Grey

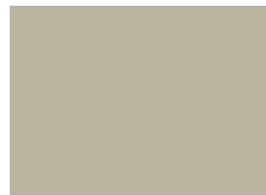

Sand

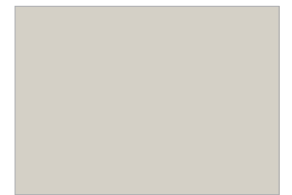

Light Tone



Wet Sand

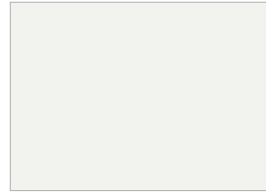

Cottonwood



Nordic *



Ultra Blue



Sky Blue



Splash



Surf's Up



Grass Green



Zesty Lime



Rubber Ducky



Nemo



Cayenne



Poppy Red



Mardi Gras



Purple Haze

Polypropylene Finishes

Standard Translucent Colours (Grazie & Strive only)



Translucent Bronze

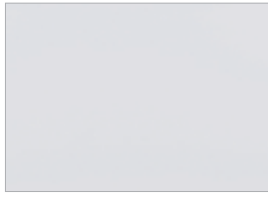

Translucent Diamond



Translucent Pewter

Strive



Grazie



Sway2 Chair, Ottoman & Table Polypropylene Parts

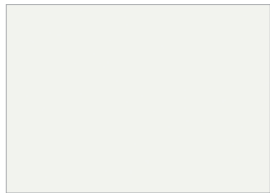

Cottonwood

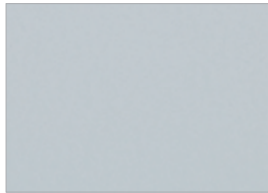

Cool Grey

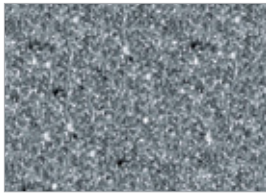

Granite Grey

Sway2 Chair

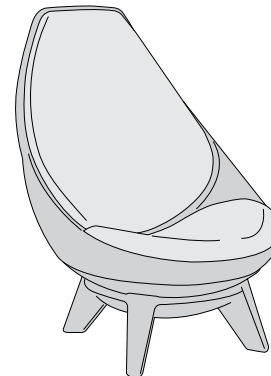

Sway2 Table

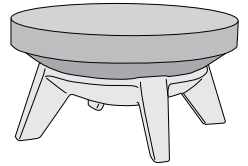

Sway2 Ottoman

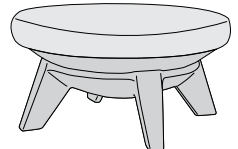

Torsion on the Go!

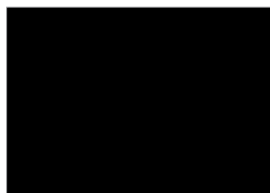

Black



Warm Grey

Torsion on the Go!



Polypropylene Finishes

Doni (Solid) - Inc. Learn2

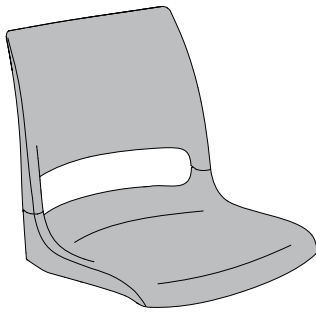

Doni (Solid Finishes)

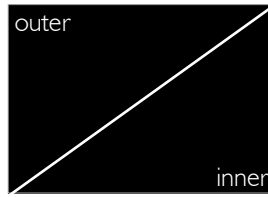

Black

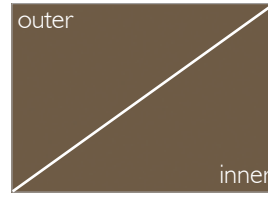

Misty Brown

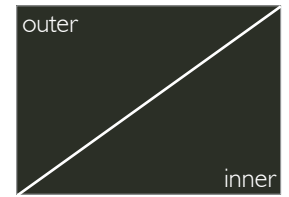

Flannel

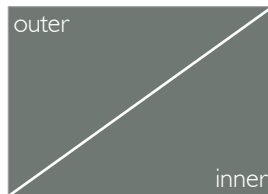

Blue Grey

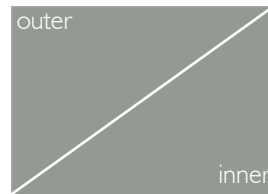

Warm Grey

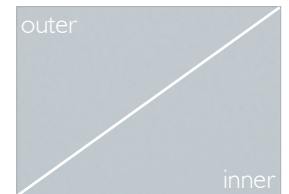

Cool Blue

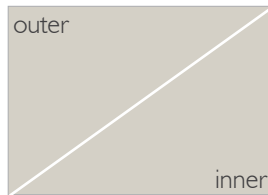

Light Tone

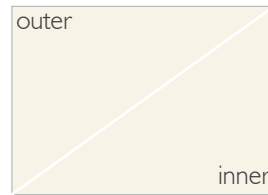

Wet Sand



Cottonwood

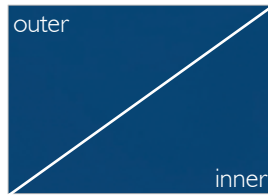

Ultra Blue

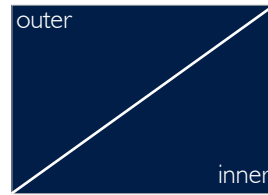

Nordic

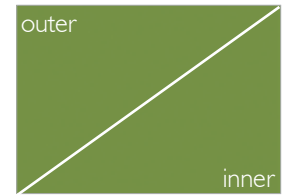

Zesty Lime

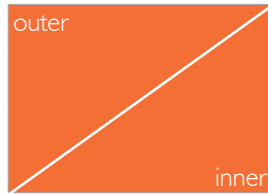

Nemo

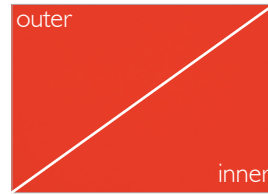

Poppy Red

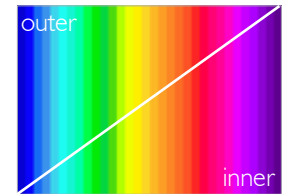

Custom Colours

Custom colours based on the Pantone reference with a minimum order of 100 units

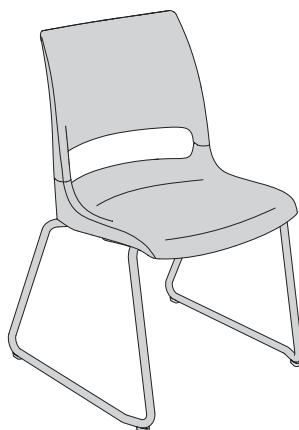
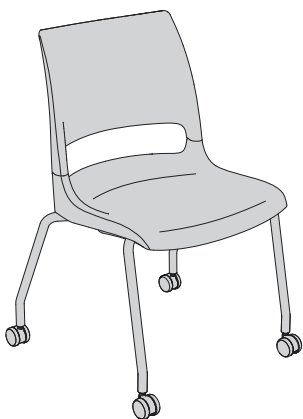

Doni (Two-Tone Finishes)



Black/Cottonwood



Misty Brown/Cottonwood

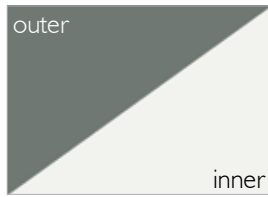

Blue Grey/Cottonwood



Cool Grey/Cottonwood



Ultra Blue/Cottonwood

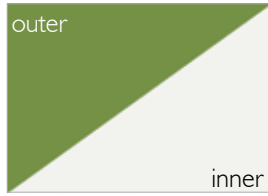

Zesty Lime/Cottonwood



Nemo/Cottonwood



Poppy Red/Cottonwood



Flannel/Warm Grey

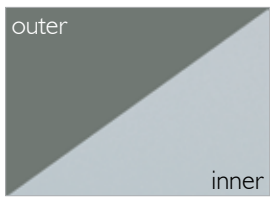

Blue Grey/Cool Grey



Nordic/Cool Grey



Surf's Up/Cool Grey

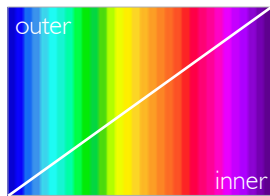

Custom Colours

Doni (Two-Tone) - Inc. Learn2

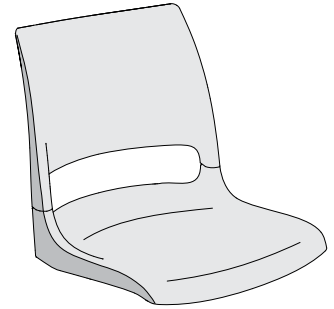

Custom colours based on the Pantone reference with a minimum order of 100 units

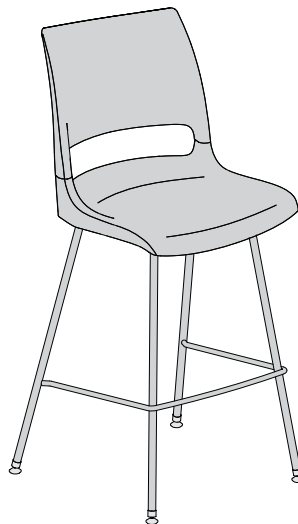
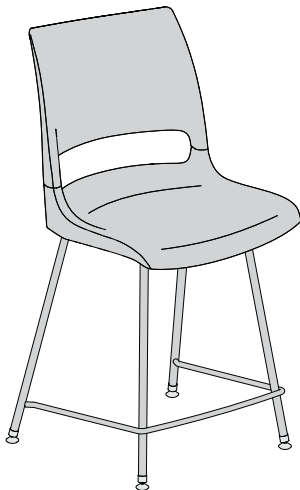
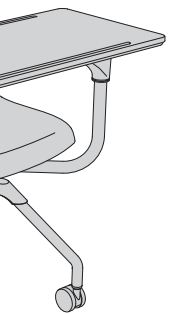

Metal Finishes

Powder coated finish with electrostatically applied epoxy powder that's baked on the metal surface. A slip additive is included on all high density stacking chairs to enhance performance.

Powder Coat Finishes



Black



Chocolate



Misty Brown



Flannel



Blue Grey



Warm Grey

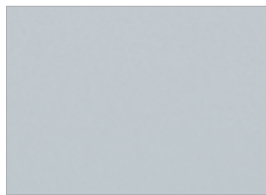

Cool Grey



Sand

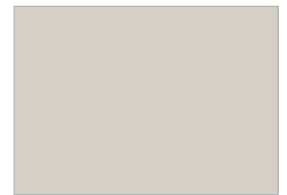

Light Tone

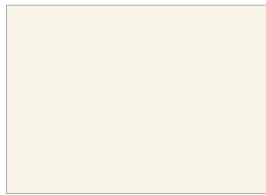

Wet Sand

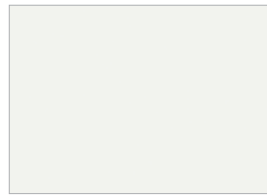

Cottonwood



Nordic



Ultra Blue



Sky Blue



Splash



Surf's Up



Grass Green



Zesty Lime



Rubber Ducky



Nemo



Cayenne



Poppy Red



Mardi Gras



Purple Haze

Metallic & Chrome Finishes



Starlight Silver



Champagne Metallic



Bronze Metallic

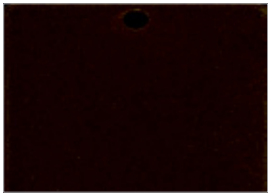

Espresso Metallic

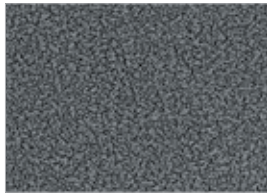

Nickel Vein



Antique Vein

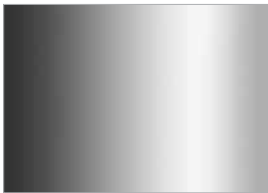

Chrome *

* Not available for Learn2

Postura+ Stools & High Chairs Finishes



Starlight Silver

Torsion on the Go! Finishes



Chrome



Black

Chrome Process

KI applies our bright nickel chromium finish with a 22-step cleaning, plating, and drying process. This process utilizes the brighter, more expensive, and more durable duplex hexavalent chromium plating material. In this duplex nickel plating, the crystal is denser than in standard commercial processes using a single bright nickel base application, which is used by most manufacturers.

KI's duplex process provides a plating depth more than three times thicker than single plating processes. Superior plating protects the base steel and reduces to absolute minimum any corrosion penetration that can occur with the single bright nickel processes used by others.

This system is designed to maximize water and chemical usage. There is nearly no chemical waste associated with this process. Plus, the waste that is created is sent to a reclaim facility, to recycle the waste back into its usable components.

The end result is a first-class plated product. With testing and laboratory support to manage the process, KI delivers the highest quality plated product in the industry.

Writing Tablets

Dimensions (mm)						
Chair	Standard Tablet	User Space	Oversize Tablet	User Space	Motion	Finish
Grazie	460x380mm	370mm	585x415mm	370mm	Flip	Laminate
Grazie G2	460x350mm	395mm	N/A	395mm	Flip/Fold	Laminate
Intellect Wave	495x380mm	395mm	565x500mm	395mm	Flip	Laminate
Intellect Wave G2	460x350mm	N/A	N/A	395mm	Flip/Fold	Laminate
Learn2 Doni	N/A	N/A	545x330mm	230-400mm	Swivel	Laminate & Polypropylene
Learn2 Grazie	N/A	N/A	545x330mm	230-350mm	Swivel	Laminate & Polypropylene
Learn2 Intellect Wave	N/A	N/A	545x330mm	230-400mm	Swivel	Laminate & Polypropylene
Learn2 Strive	N/A	N/A	545x330mm	230-350mm	Swivel	Laminate & Polypropylene
Maestro HD	520x305mm	405mm	N/A	N/A	Flip	Laminate
Matrix HD	520x305mm	380mm	520x430mm	355mm	Flip	Laminate
Perry HD	520x305mm	425mm	520x430mm	380mm	Flip	Laminate
Strive 4 leg	495x380mm	355mm	585x415mm	355mm	Flip	Laminate
Strive HD	520x305mm	445mm	N/A	N/A	Flip	Laminate
Strive nesting	495x380mm	355mm	585x415mm	355mm	Flip	Laminate
Torsion on the Go!	N/A	N/A	520x440mm	380-455mm	Flip/Fold	Polypropylene

User space measurement equal to inside edge of tablet to seat back

HD - High Density Chairs

- Tablets are available left or right handed
- Tablets for Maestro chairs available from stock in Graphite Nebula
- Chrome finish to metalwork only
- Removable
- Non stacking

Laminate

- 18mm thick Baltic Birch plywood core
- 10mm laminate face and 5mm paper backing sheet
- The edge of the wood surface is shaped and sanded with a sealed and clear coat lacquered finish

BIFMA Standards

- All KI tablets pass BIFMA standards
- Tablet Arm Durability - Cyclic – 35kg vertical force applied to the tablet 100,000 times
- Tablet Arm Strength – 68kg vertical force applied to the tablet once

Removable Tablet Arm for Maestro HD

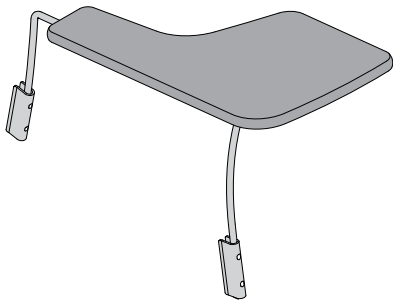

Grazie 4 Leg Chair with G2 Tablet Arm



Strive Nesting Chair with Oversized Tablet Arm



Removable Tablet Arm for Matrix HD in Standard & Oversized

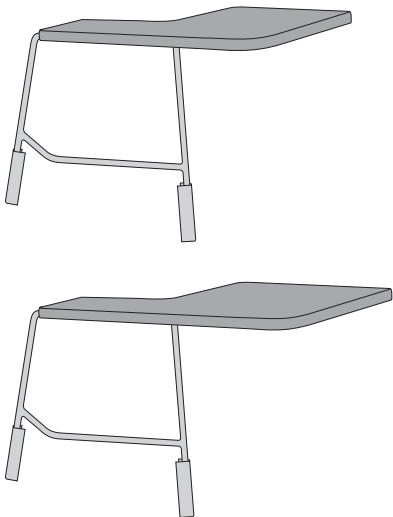

Intellect Wave G2 Tablet Arm Chair

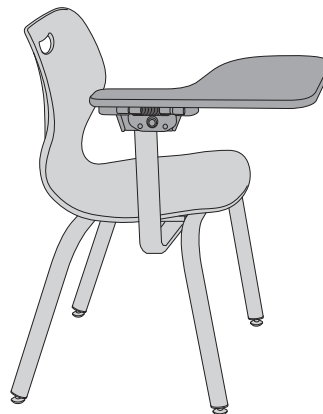

Strive Sled Base Chair with Standard Tablet Arm

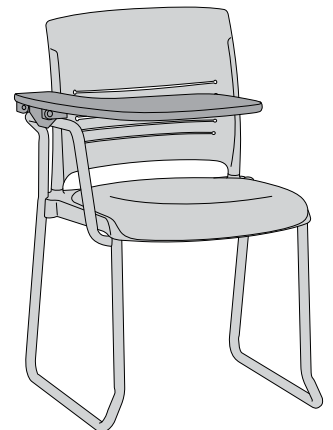

Removable Tablet Arm for Strive HD

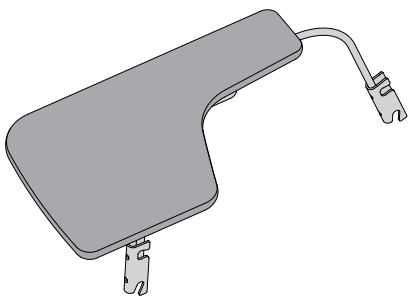

Removable Tablet Arm for Perry HD in Standard & Oversized

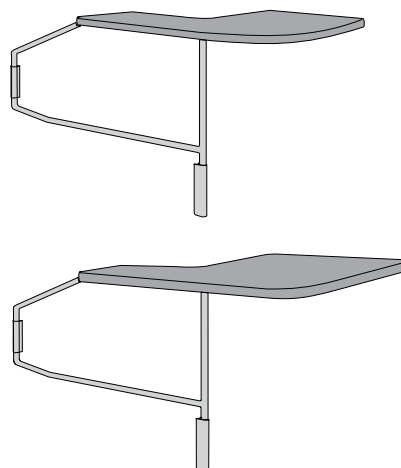

Learn2 Laminate Tablet Arm

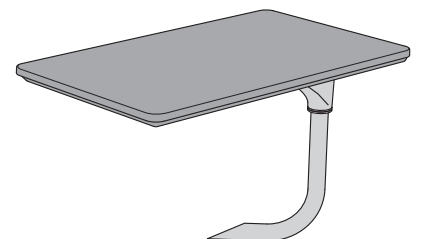

Writing Tablets

Laminate Finishes



Frosty White

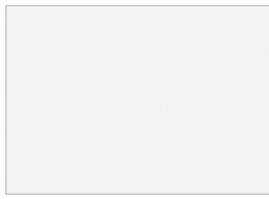

White Markerboard



White Sand



Grey



Grey Moss



North Sea



Black



Coffee Bean



Hollyberry



Orange Grove



Island



Ocean



Lapis Blue

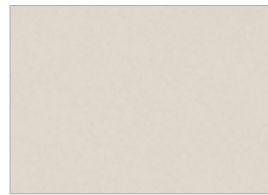

Pearl Bisque

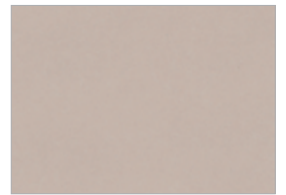

Pearl Dust



Pearl Silver



Satin Stainless



Satin Oxide



Kensington Maple



Castle Oak



Monticello Maple



River Cherry



Cherry Storm

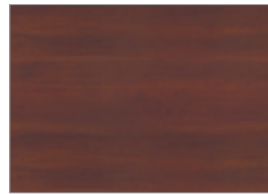

Biltmore Cherry



Windsor Mahogany



Brighton Walnut



Cocobala



Sterling Ash

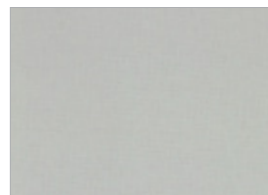

Crisp Linen



Classic Linen

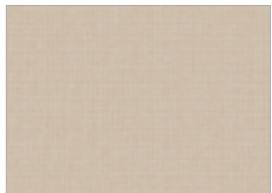

Flax Linen

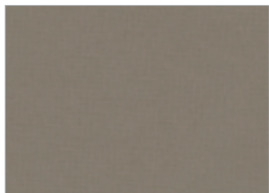

Casual Linen

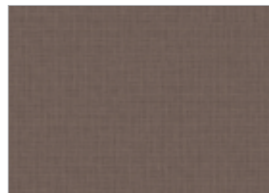

Rugged Linen

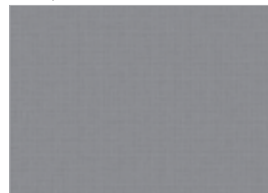

Pressed Linen

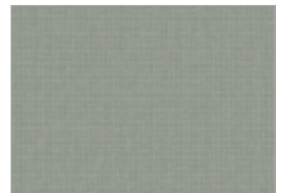

Irish Linen



Tailored Linen

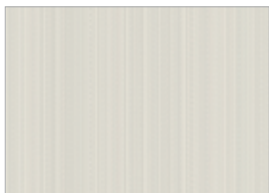

High Rise

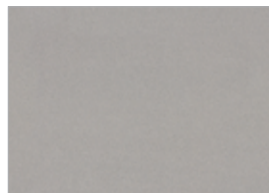

White Nebula



Graphite Nebula

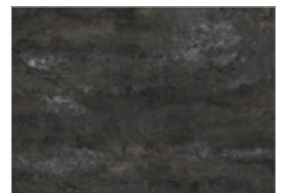

Forged Steel

Laminate Finishes Continued



Spiced Zephyr



Loden Zephyr



Misted Zephyr



Canyon Zephyr



Morro Zephyr



Fired Steel



Titanium Evolv



Silicon Evolv



Nickel Evolv



Tungsten Evolv

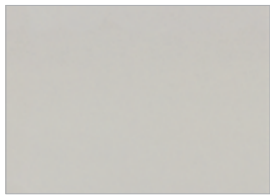

Shadow Zephyr



Cloud Zephyr



Desert Zephyr

Polypropylene Tablet Finishes - Learn2



Warm Grey



Flannel



Black

Learn2 Polypropylene Tablet Arm

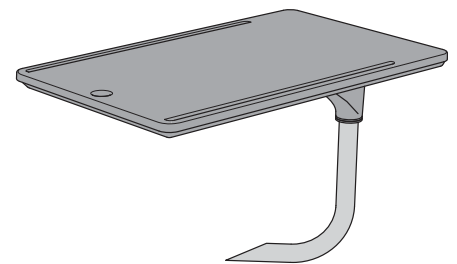

Polypropylene Tablet Finishes - Torsion on the Go!

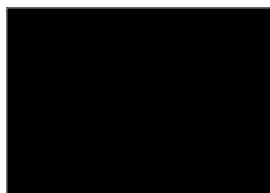

Black

Torsion on the Go! Tablet Arm

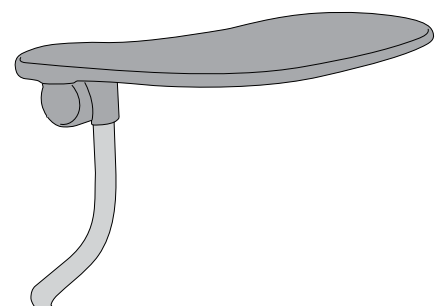

Sway2 Table - Laminate Finishes

Sway2 Table

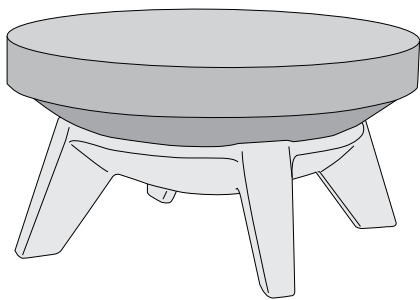

For polypropylene base finishes,
refer to p.7

Sway2 Table Top Finishes

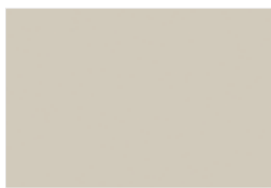

White Sand



Grey Moss



North Sea

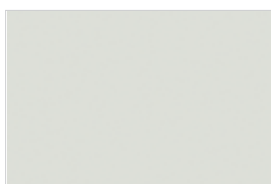

Frosty White



Grey



Coffee Bean



Hollyberry



Black

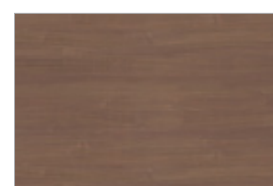

River Cherry



Kensington Maple

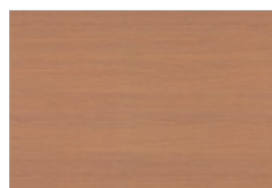

Castle Oak



Monticello Maple



Biltmore Cherry

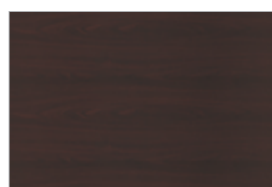

Brighton Walnut

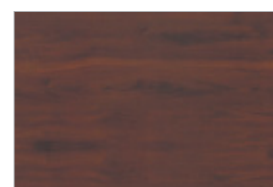

Windsor Mahogany

Fabric Bands

Band 1 (Fabric)

Camira Advantage
Camira Phoenix

Band 2 (Fabric)

Camira Canopy
Camira Chateau
Camira Gravity
Camira Honeycomb
Camira Mainline Flax
Camira Mainline Plus
Camira Manhattan
Camira Sprint
Camira Urban
Camira Velocity
Camira X2
Camira Xtreme

Band 3 (Fabric)

Camira Aquarius
Camira Hebden
Camira Hi-Tech
Camira Landscape
Camira Marvel
Camira Silk
Camira Synergy
Camira Track
Camira Trail

Band 2 (Vinyl)

Chieftain Just Colour

An upholstered seat pad not only offers longer comfort, but the use of fabric can also create vibrant designs and textures that stimulate students in an Education environment.

- Industry leading fabric manufacturers
- Independently tested fabrics
- Warranties as per manufacturers specifications

For individual fabric certification & to order samples visit:

Fabric: www.camirafabrics.com

Vinyl: www.chieftainfabrics.com

NOTE:

Minimum order quantity is 4 x seat pads

Upholstery extends the lead time by an additional 2 weeks but is subject to peak seasonality and order volumes.

For any fabrics not listed contact KI to check availability.



Upholstery Options

The fabrics displayed are the closest matches to our standard Postura+ polypropylene colour range, minimum order is 4x seat pads.

* no minimum order quantity

Contrasting colours available, please refer to fabric bands on page 18.

Camira Advantage is a Low Hazard commercial seating fabric, Advantage, offers a combination of enduring aesthetic appeal and high performance durability which means it will look good and last for years.

Advantage is a plain weave fabric in a rich assortment of colourways in both plains and mixes.

For the full range please visit:
www.camirafabrics.com/fabrics-and-samples/advantage

Fabric Seat Pads for Postura+ (Camira Advantage, Band 1)



Sugar Plum

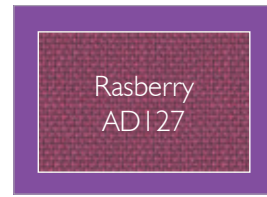

Grape Crush



Pink Candy



Powder Blue

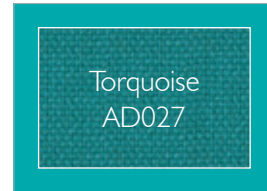

Aqua Blue

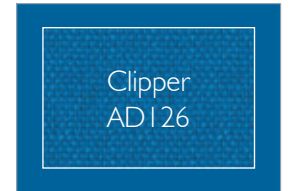

Ink Blue *



Forest Green

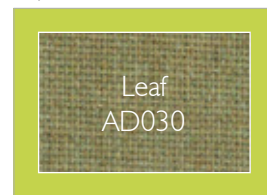

Lime Zest

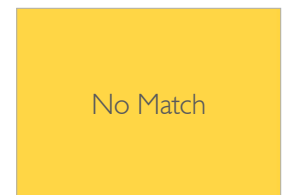

Sun Yellow



Tangerine Fizz



Poppy Red

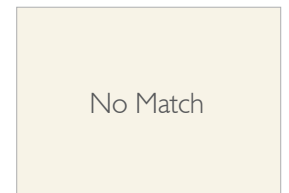

Almond White

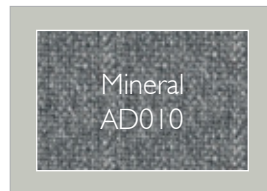

Ash Grey

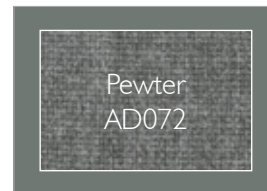

Iron Grey

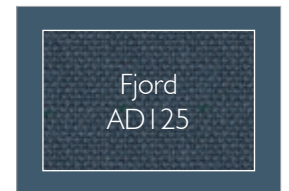

Slate Grey *

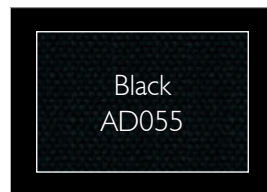

Jet Black

Vinyl Seat Pads for Postura+ (Chieftain Just Colour, Band 2)



Sugar Plum

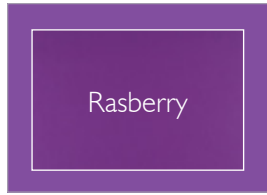

Grape Crush

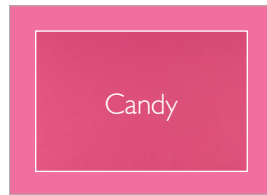

Pink Candy



Powder Blue

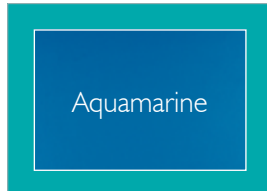

Aqua Blue



Ink Blue

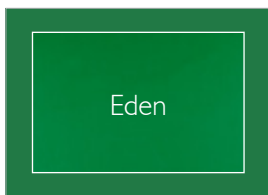

Forest Green



Lime Zest

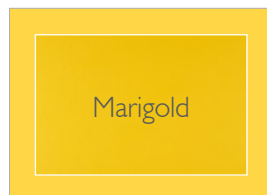

Sun Yellow

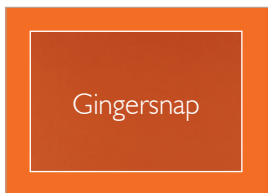

Tangerine Fizz



Poppy Red

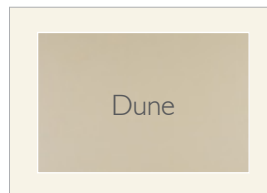

Almond White

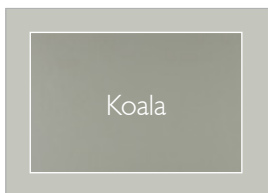

Ash Grey

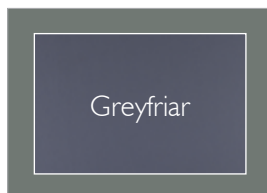

Iron Grey

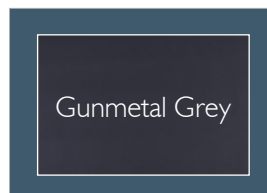

Slate Grey

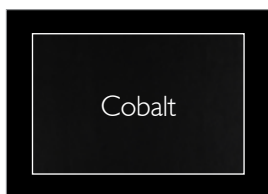

Jet Black

The vinyl displayed are the closest matches to our standard Postura+ polypropylene colour range, minimum order is 4x seat pads.

Just Colour is a Crib 7 vinyl with a soft feel. It is REACH compliant, phthalate free and is anti-microbial.

It comes in a range of 54 bright and elegant colours. It has been tested to 500,000 rubs and we guarantee it for 3 years.

For the full range please visit:
www.chieftainfabrics.com/product-category/just-colour/



KI (UK) Ltd
New Fetter Place
8-10 New Fetter Lane
London, EC4A 1AZ
Tel.: +44 (0)20 7405 7082
education@kieurope.com
www.kieurope.com/education

*KI and Furnishing Knowledge are registered
trademarks of Krueger International Inc*

