



Chroma power module features colour, new clamping fixtures, smart charge and a sleek finish to the office desk!



FASTER
TIDIER
SMARTER

Top Fixing 30 and 60 degree

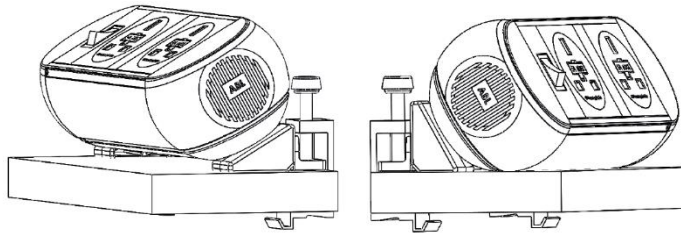

Under desk fixing 30 and 60 degree

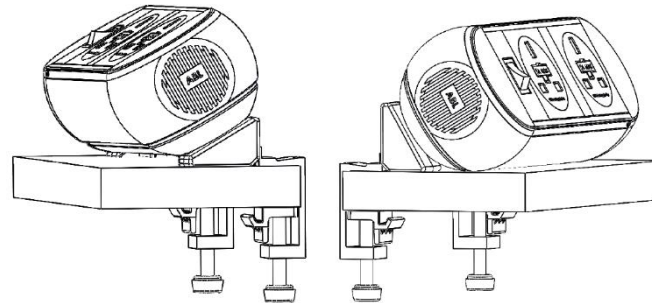

Changeable rings available in blue, green, yellow and red.

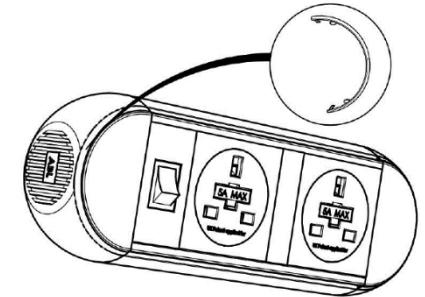

Step 1

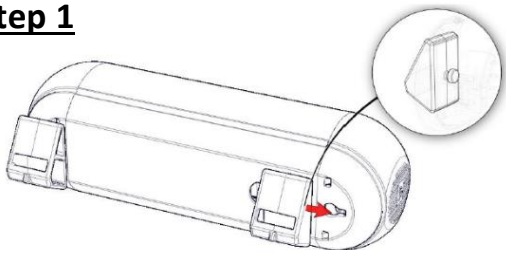

Under desk and top fixing

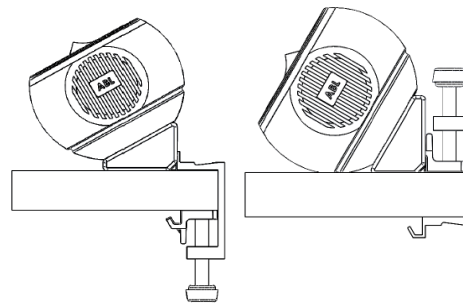

To change coloured rings, use a small screwdriver to clip off one side and easily remove the other. To insert a new ring simply clip one side of the ring into the module and gently fix the other side until you hear a click sound.

Step 2

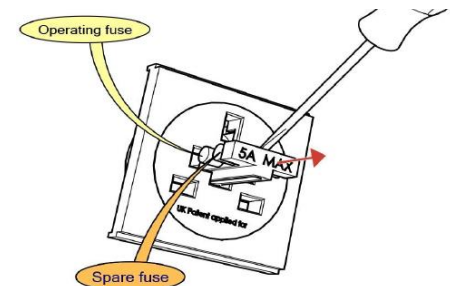
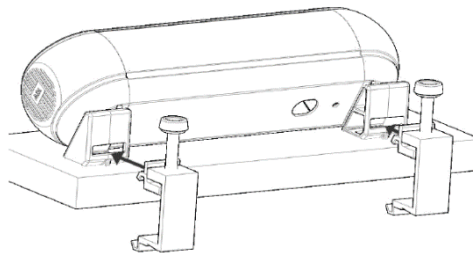

Step 3

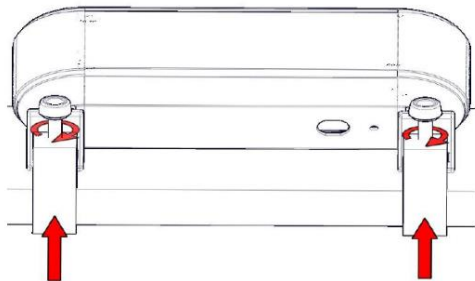

30 and 60 degree positioning

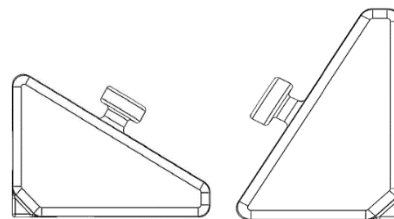

To change the fuse, please **TURN ELECTRICITY OFF** and wait for 10 minutes before operating. Use a flat screwdriver (5mm width) to pull out carrier with fuse and re-place with spare one.

Technical Specification



Thank you for purchasing ABL's Chroma power module unit. Chroma has been manufactured and tested in accordance with relevant British Standards. This will enable the requirements of BS6396:2008 to be met (if installed and tested as specified in the standard) Once installed and tested, any modifications should be carried out by a competent person.

USE: This power module is designed for use in office and educational establishments only. The individual fuse rating for each socket will be a maximum of 5A as specified on the product, any item of equipment rated in excess of 5 Amp, **MUST** have a separate power supply, therefore items such as Vacuum Cleaners, Kettles, Coffee Makers, and Fan Heaters should not be connected via these power modules.

FUSES: The fuses in the product are ceramic 5mm x 20mm either 3.15A or 5A rated. Should replacements be required please contact the company that supplied this product.

FIXING: Use only the fixings shown in the leaflet to mount this product.

CONNECTION: Using the mains extension lead that may be supplied, connect this into the short tail lead on the rear of the product. If included in this product also plug the other connection leads into the sockets on the rear of the product (ensure the Non Booted end is plugged into the product) Should you need to re-site this product and require shorter or longer leads, simply replace the leads supplied with the appropriate length leads which can be obtained from the supplier of the product.

EARTHING: The Earth Point on the rear of this product is provided so that the furniture may be earthed via this system if required. 'Earth Designated Furniture' The furniture manufacturer should be able to advise if their furniture requires earthing or not. **THIS PRODUCT IS EARTHED INTERNALLY AND NO FURTHER EARTHING SHOULD BE REQUIRED, (For High Density earth requirements please consult a suitably competent person)**

MAINTENANCE: There are no user serviceable parts in this product, a suitably competent person may replace fuses or make alterations to lead lengths should this be necessary

INSTALLER, PLEASE LEAVE THIS SHEET WITH THE END USER FOR FUTURE REFERENCE.