

ACOUSTIC ARTWORK PET felt products



FEATURES

- Sustainable product – partially from post-consumer PET and easily recyclable
- Customization options – colours and patterns
- Quick and easy assembly and disassembly
- Certified sound absorption, NRC = 0,77

TECHNICAL INFORMATION

Screen composition

- PET fiber board 9 mm

Set of suspensions AWZ001 (2 pcs.)

- Suitable only for PET partitions (up to 10 mm thick);
- Only a single product can be suspended per set;
- Set includes ceiling mounting (masonry/wood/gypsum);
- Adjustable cable gripper;
- Ø1,5 mm wire rope L-50-2000 mm.

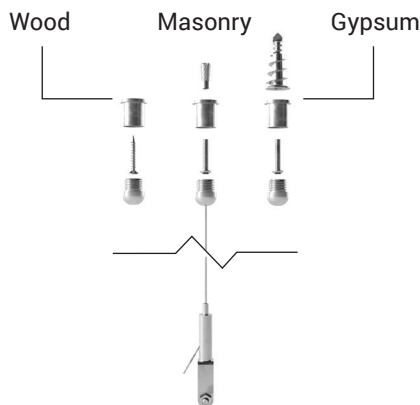

Set of suspensions AWZ004 (2 pcs.)

- Suitable only for PET partitions (up to 10 mm thick);
- Only a single product can be suspended per set;
- Set includes ceiling mounting (for T24 Armstrong profile);
- Adjustable cable gripper;
- Ø1,5 mm wire rope L-50-2000 mm.

T24 Armstrong profile



Set of suspensions AWZ002 (1 pc.)

- Suitable only for PET clouds;
- Only a single product can be suspended per set;
- Set includes ceiling mounting (masonry/wood/gypsum);
- Ø1,5 mm wire rope L-50-2000 mm;
- Adjustable cable gripper;
- Two Ø1,5 mm wire ropes with metal plates L-1500 mm.

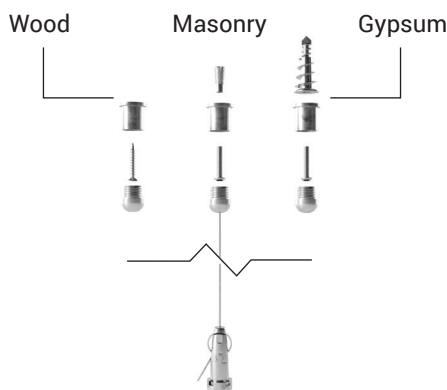

Set of suspensions AWZ003 (1 pc.)

- Suitable only for PET clouds;
- Only a single product can be suspended per set;
- Set includes ceiling mounting (for T24 Armstrong profile);
- Ø1,5 mm wire rope L-50-2000 mm;
- Adjustable cable gripper;
- Two Ø1,5 mm wire ropes with metal plates L-1500 mm.

T24 Armstrong profile



Adhesive fittings

- Included for each PET tile;
- Thickness 0,2 mm;
- Temperature for application or removal min 15°C;
- Temperature resistance 5-35°C;
- Adhesive fittings for wall or ceiling (glass / wood / plastic / ceramics / varnished surfaces)*;
- Not suitable for use on vinyl wallpaper and anti-stick surfaces;

* The adhesive must flow onto the surface and create full surface contact. The surface to be bond must be free of grease, loose particles and moisture!

RANGE

PET partition pattern types

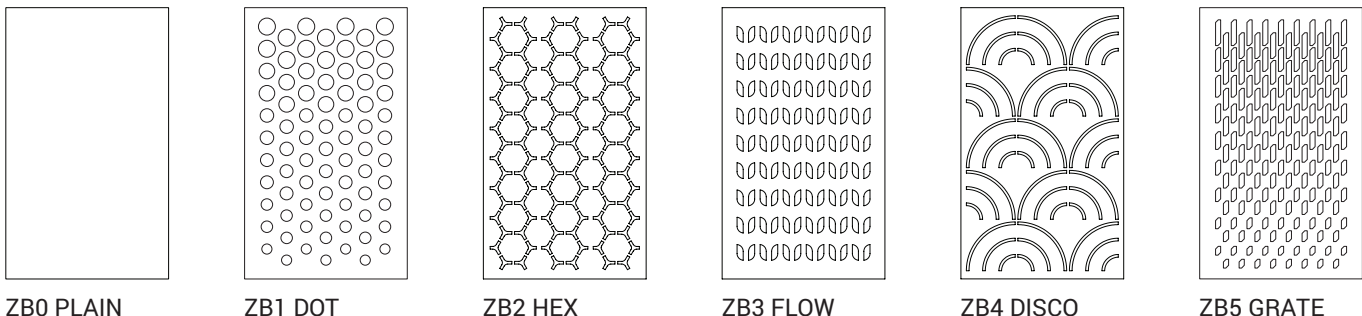

ZB0 PLAIN ZB1 DOT ZB2 HEX ZB3 FLOW ZB4 DISCO ZB5 GRATE

PET partition sizes

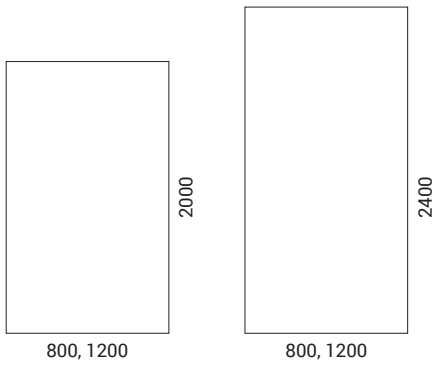

PET cloud sizes

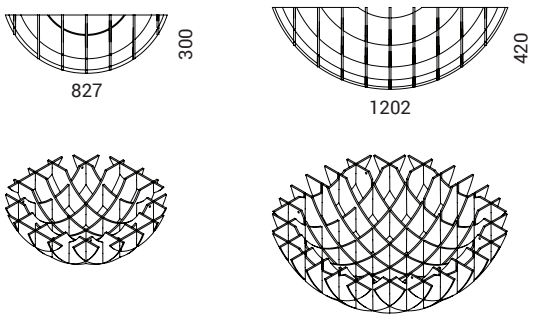

PET tiles types and sizes

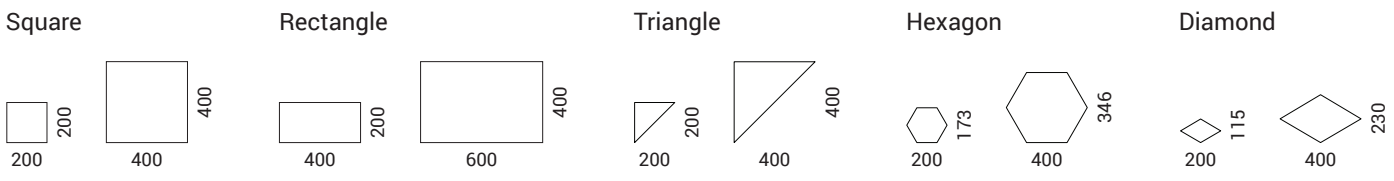

ADDITIONAL INFORMATION

To ensure smooth and easy assembly PET partitions are delivered without holes for fittings. This is done in order to mitigate any problems which may hinder assembly such as placement of ducting, lighting or internal building constructions.

Caution

Only one way of PET Cloud suspension is allowed. Suspending product incorrectly may lead to product damage or people injury.



Recommendations for use

PET partition patterns were designed for vertical use. Although it is not forbidden to suspend this product horizontally, we cannot guarantee performance and aesthetic look of the partition.

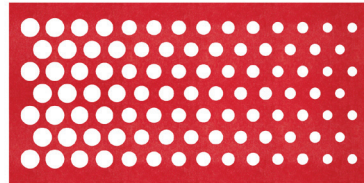
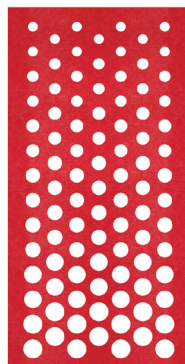
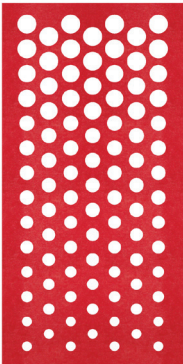

Please note that due to the size and shape of the PET Tiles not every Tile can be combined to create a uniform composition.

