

SILENT ROOM M

Technical information

www.millarwest.co.uk



Other documents available for this product

Technical information for SILENT ROOM S, L, XL

Ordering guidelines for SILENT ROOM

User manual for SILENT ROOM

Troubleshooting manual for SILENT ROOM

Technical guide for SILENT ROOM

Warranty

See Warranty statement



Technical information

External Walls

Options

- Upholstered with fabric (1)
- Melamine (2)
- Upholstered with fabric. Rear wall with glass (3)
- Melamine. Rear wall with glass (4)

5 panels upholstered with fabric

- Welded frame is made of metal tube 40x20 mm;
- Angular brackets are made of 40x40 mm metal tubes;
- Powder coated metal;
- Plastic feet with height levelling (+30 mm);
- 12 mm MFC (melamine);
- Covered with 3 mm foam;
- Upholstered with fabric.

1 solid panel from melamine

- Welded frame is made of metal tube 40x20 mm;
- Angular brackets are made of 40x40 mm metal tubes;
- Powder coated metal;
- Plastic feet with height levelling (+30 mm);
- 16 mm MFC (melamine) with 1 mm ABS edging.

Walls with glass panes

- Welded frame is made of metal tube 40x20 mm;
- Powder coated metal;
- Inside gasket is made of 12 mm MFC (melamine) with 1 mm ABS edging;
- Front sides and top of the metal frame are covered with 16 mm MFC (melamine) with 1 mm ABS edging;
- 8 mm TSG (tempered safety glass), clear.

1



2

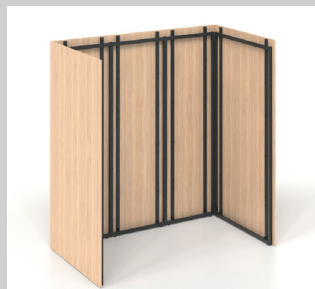

3

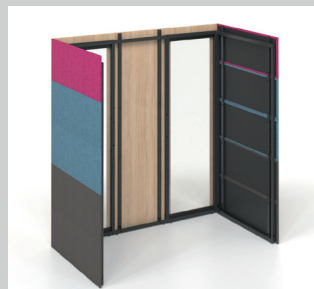

4

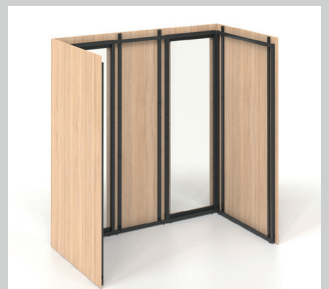

Internal acoustic walls (1)

Panels upholstered with fabric

- Frame is made of 40x20 mm metal tube;
- Powder coated metal;
- 12 mm MFC (melamine);
- 40 mm of acoustic foam;
- Upholstered with fabric.

Internal front walls

Options

- Upholstered with fabric (2)
- Melamine panel (3)
- If you order external walls with glass panes, you do not need to choose internal front walls

Melamine panel

- Frame is made of 40x20 mm metal tube;
- Powder coated metal;
- 16 mm MFC (melamine) with 1 mm ABS edging.

Panels upholstered with fabric

- Frame is made of 40x20 mm metal tube;
- Powder coated metal;
- 12 mm MFC (melamine);
- Covered with 3 mm foam;
- Upholstered with fabric.

1



2

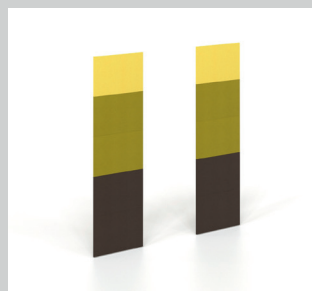

3



Internal front central wall

Options

- Internal front central wall with electronic control system (1)
- Internal front central wall with low table, VESA mount and electronic control system (2)
- Internal front central wall with high table, VESA mount and electronic control system (3)

Wall with control unit

- Top front panel is made of 16 mm MFC with 1 mm ABS edging;
- Bottom front panel with hinges is made of 16 mm MFC with 1 mm ABS edging;
- Sides and internal construction parts are made of 16 mm MFC with 0,5 mm ABS edging;
- Ventilation and lighting dimming knobs are made of PA 2200 (Nylon);
- Cable guides are located on both sides of the wall (only for units without tables).

Table

- 720 mm or 1050 mm tabletop height option;
- Tabletop is made of 16 mm MFC (melamine) with 1 mm ABS edging;
- Box for wires (135x150x100 mm) underneath the table top is made of 1 mm powder coated metal sheet;
- Table frame is made of 40x20 mm metal tube;
- Top of the leg is made of 70x20 mm metal tube;
- Leg base is made of 40x40 mm metal tube;
- Powder coated metal;
- Feet with height levelling (+10 mm).

Control box (3)

- Input (GST18i3 male): 100-240 V;
- Output (GST18i3 female): 100-240 V;
- Frequency: 50/60 Hz;
- Power cable: EU, UK, FR, CH, US – GST18i3 female, 3 m;
- Power output cable length: 0,5 m – GST18i3 male – GST18i3 female;
- Power consumption – max. 229W, standby 4,5W.

Screen bracket

- Screen bracket base is made from 70x20 mm powder coated metal tube;
- VESA plate (120x120 mm) is made of 2 mm metal sheet;
- VESA standards – 75x75 mm, 100x100 mm and recommended weight is up to 10 kg;
- Recommended screen size is up to 27”;
- VESA plate can be fixed to the holder in 3 different heights;
- Bolts for flat screen assembly are not included.

1

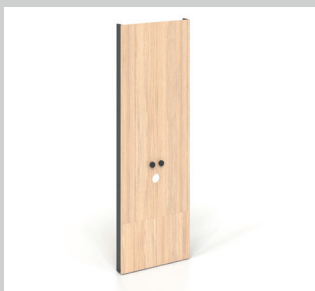

2



3

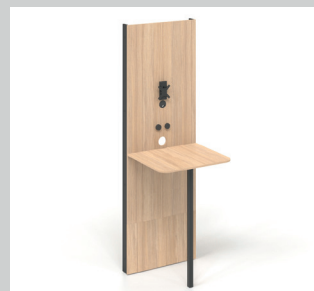

4



Ceiling (1)

Composition

- Double layered ceilings are made of 12 mm top and 16 mm bottom MFC (melamine) panels with 1 mm ABS edging;
- Frame is made of 50x20 mm metal tube;
- PIR sensor mounted in to central ceiling segment;
- Fan grills are made of 1 mm metal sheet;
- Powder coated metal;
- Air supply duct inside glued with acoustic foam;
- Ø60 mm cable grommet for optional power supply from ceiling.

Lighting

- 3x LED modules (8,92W) colour temperature approx. 3000 K dimmable;
- 3x LED housing (asymmetrical) made of aluminium;
- Replacement for LED modules can only be purchased from the manufacturer.

Ventilation

- 4x air supply fans are located in central segment of the ceilings;
- 4x air exhaust slots are located in central segment of the ceilings for natural ventilation;
- Maximum airflow approx. 400 m³/h.

Glass facade with doors (2)

Doors

- Left-handed or right-handed option;
- Metal door frame is made of 40x40 mm tube and 40x8 mm steel rod;
- Powder coated metal;
- Aluminium profiles with PVC sealing fixed to internal sides and top and bottom of door frame;
- Top of the metal frame is covered with 16 mm MFC (melamine) with 1 mm ABS edging;
- 8 mm TSG (tempered safety glass), clear;
- Clear width of a door opening - 750 mm.

Glass facade

- Metal door frame is made of 40x20 mm tube;
- Powder coated metal;
- Inside gasket is made of 12 mm MFC (melamine) with 1 mm ABS edging;
- Front sides and top of the metal frame are covered with 16 mm MFC (melamine) with 1 mm ABS edging;
- 8 mm TSG (tempered safety glass), clear.

1

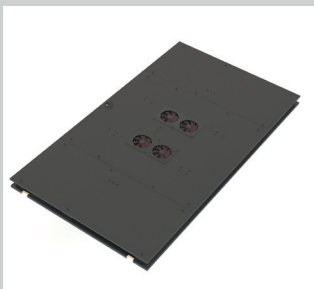

2



Floors (optional) (1)

- Metal floor frame is made of 40x40 mm and 40x20 mm tube;
- Powder coated metal;
- Floor panels are made of 25 mm MFC with 0,5 mm ABS edging;
- Floor carpet thickness 3 mm, made of PA6 (40%) and PP (60%);
- Skirting boards made of 16 mm MFC with 1 mm ABS edging;
- Plastic feet with height levelling (+30 mm).
- Note that the floor adds approximately 70 mm to the overall height.

Carpet (optional) (2)

- Carpet thickness 6,5 mm, made of 100% polyamide, antistatic;
- It is highly recommended to use the carpet when placing the SILENT ROOM on the hard flooring.
- If you are planning to place the SILENT ROOM on your carpet, you do not need to order the additional carpet.
- Uneven floor can be the cause of sound insulation problems.

1



2



Electrical specification

Power socket (ARU704)

- 1 AC power socket 100-240 V;
- Integrated USB fast charger (USB Type A+C, max 5A);
- 1 cable guide for multimedia cable;
- Mounting in Ø80 mm cut-out;
- Dimensions: Ø90x66 mm;
- Power socket standards: EU, FR, UK, CH, US;
- Cable length: 0,8 m.

Power socket (ARU703)

- 1 AC power socket 100-240 V;
- Dimensions: 90x66 mm;
- Mounting in Ø80 mm cut-out;
- Power socket standards: EU, FR, UK, CH, US;
- Cable length: 0,8 m.

Power socket block set for media (ZZZ336)

- 3 AC power sockets 100-240 V;
- Dimensions: 260x60x45 mm;
- Adaptor block GST18i3 T-type - 1x male, 2x female;
- Power socket standards: EU, FR, UK, CH, US;
- Extension cable length: 0,5 m - GST18i3 male - GST18i3 female.

ARU704



ARU703



ZZZ336



Power unit for media wall (ZZZ340)

- 3 AC power sockets 100-240 V;
- Dimensions: 260x60x45 mm;
- Metal frame 317x119x40, made from 2 mm metal sheet;
- Powder coated metal;
- Mounting in 300x110 mm cut-out;
- Power socket standards: EU, FR, UK, CH, US;
- Extension cable length: 1 m - GST18i3 male - GST18i3 female.

Power unit for media wall (ZZZ341)

- 2 AC power sockets 100-240 V;
- 1 LAN outlet (CAT6 RJ45) with 2 m flylead;
- Dimensions: 260x60x45 mm;
- Metal frame 317x119x40, made from 2 mm metal sheet;
- Powder coated metal;
- Mounting in 300x110 mm cut-out;
- Power socket standards: EU, FR, UK, CH, US;
- Extension cable length: 1 m - GST18i3 male - GST18i3 female.

Power unit for media wall (ZZZ342)

- 2 AC power sockets 100-240 V;
- 1 Integrated USB fast charger (Type A+C, max 5A);
- Dimensions: 260x60x45 mm;
- Metal frame 317x119x40, made from 2 mm metal sheet;
- Powder coated metal;
- Mounting in 300x110 mm cut-out;
- Power socket standards: EU, FR, UK, CH, US;
- Extension cable length: 1 m - GST18i3 male - GST18i3 female

Power unit for media wall (ZZZ343)

- 1 AC power sockets 100-240 V;
- 1 Integrated USB fast charger (Type A+C, max 5A);
- 1 LAN outlet (CAT6 RJ45) with 2 m flylead;
- Dimensions: 260x60x45 mm;
- Metal frame 317x119x40, made from 2 mm metal sheet;
- Powder coated metal;
- Mounting in 300x110 mm cut-out;
- Power socket standards: EU, FR, UK, CH, US;
- Extension cable length: 1 m - GST18i3 male - GST18i3 female.

ZZZ340



ZZZ341



ZZZ342



ZZZ343



Range

Fabric + fabric back version

Product weight: 458 kg

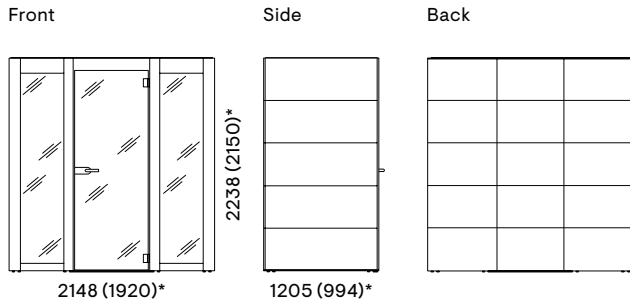

Total height with floor: 2306 mm

Melamine + melamine back version

Product weight: 472 kg

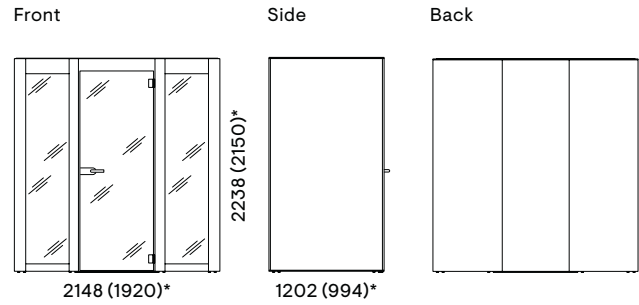

Total height with floor: 2306 mm

Fabric + glass back version

Product weight: 448 kg

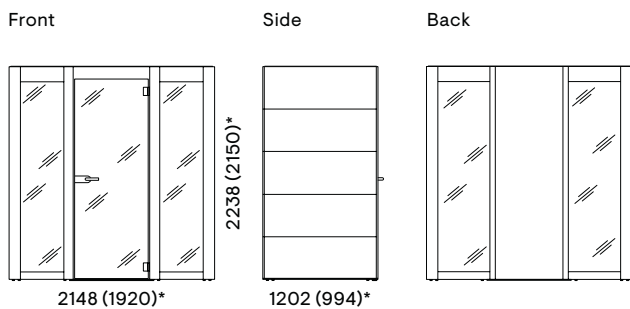

Total height with floor: 2306 mm

Melamine + glass back version

Product weight: 454 kg

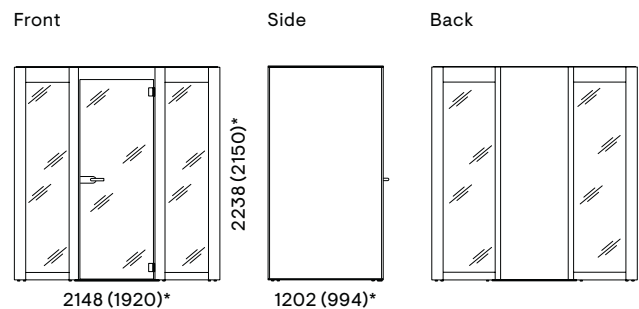

Total height with floor: 2306 mm

* External dimension (internal dimension)

!

Recommended height of the space for SILENT ROOM installation – ≥ 2400 mm (without floor).

Recommended height of the space for SILENT ROOM installation – ≥ 2470 mm (with floor).

Additional information

Shipping dimensions

WxDxH: 2250x1180x1080 mm
(Accessories and poufs are not included)

Height of shipping dimensions will be slightly smaller for SILENT ROOM with external rear wall with glass panes.

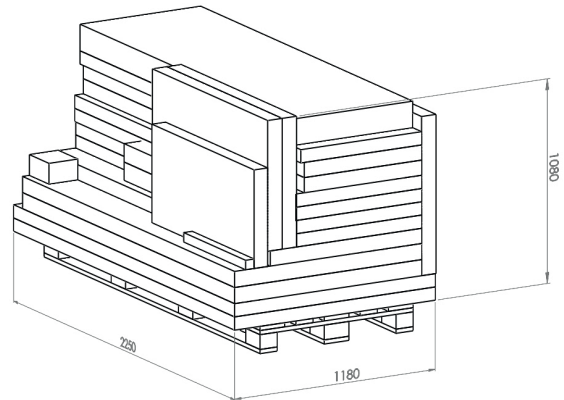

Automatic operation

