

BOXI towers



FEATURES

- 2 widths – 360 mm, 420 mm;
- 2 depths: 800 mm (for single desks), 820 mm (for bench desks);
- 3 heights: 740 mm, 1090 mm, 1200 mm;
- Different inner combinations.

QUALITY STANDARD

- EN 14073-2:2004
- EN 14073-3:2004
- EN 14074:2004

TECHNICAL INFORMATION

Carcass

- Made of 16 mm MFC (melamine) with 1 mm edging;
- Made of 18 mm MFC (melamine) with 1 mm edging;
- Made of 25 mm MFC (melamine) with 2 mm edging (only for H=740 mm top and H=1090 mm middle top).



Handle type (colour + handle code)

Legs

- Four plastic height levelling feet, H=23 mm (+10 mm);
- 1 castor Ø80 mm (tread from thermoplastic rubber, non-marking).

Inner file drawers (TBR/TBL309-310)

- Made of 12 mm MFC (melamine) with 1 mm edging;
- Full extension ball bearing slides, which are visible;
- Height – 280 mm, depth – 350 mm, width – 646 mm;
- Convenient opening without handles.



Fixed metal shelves (TBR/TBL309-316)

- Made of 1 mm thick steel sheet;
- Powder coated metal;
- Fixed with screws.

USB fast charger (TBR/TBL313-314)

- A+C Twin USB Fast Charger integrated into the back panel of the cabinet;
- Hardwired power cord to GST18-3 800 mm;
- Cable length: 3 m;
- Dimensions: Ø74x50 mm;
- Cable standard: UK, EU, CH, FR, US;
- R letter means that if the port is damaged, you can change it without replacing the whole socket;
- Black plastic.

Pull-out drawer

- Made of 18 mm MFC (melamine) with 1 mm edging (except file tower, and towers which are 360 mm width, there are parts which are made of 16 mm MFC (melamine));
- Soft closing function;
- Lockable;
- Load max. 50 kg;
- Plastic pen holder is integrated in the upper shelf (TBR/TBL201-202, TBR/TBL307-308).

Sliding doors (TBR/TBL303-304)

- Made of 10 mm plywood with laminate, edges – lacquered;
- No handles (just cut-outs);
- White plastic slide profile.

Inner personal drawers (TBR/TBL311-316)

- Made of 12 mm MFC (melamine) with 1 mm edging;
- Full extension ball bearing slides, which are visible;
- Height – 120 mm, depth – 300 mm, width – 450 mm;
- Convenient opening without handles.



Power socket (TBR/TBL315-316)

- 1 AC power socket 100 – 230 V;
- Hardwired power cord to GST18-3 800 mm;
- Cable length: 3 m;
- Dimensions: Ø74x50 mm, hole for socket Ø60 mm;
- Power socket standards: UK, EU, CH, FR, US;
- Black plastic.

Hook for clothes

- Dimensions: 20x28, H=62 mm;
- Powder coated metal;
- Fixed with screws.

Felt-lined inserts

- For towers with metal shelves;
- 2 sizes: 671x198x2 mm, 450x343x2 mm;
- Suitable with ERA, LUCIA, VELITO PRESTO, SYNERGY;
- Optional, need to be ordered separately.

RANGE

Towers*

*R/H or L/H option available

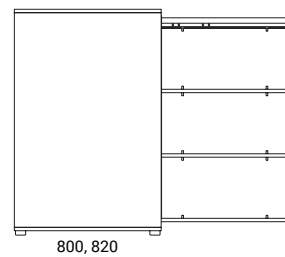
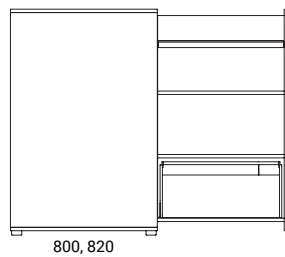
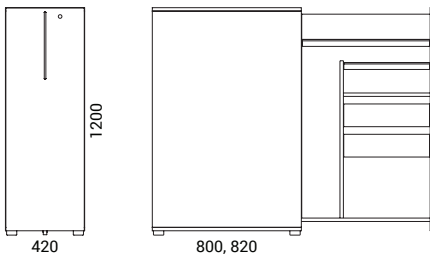
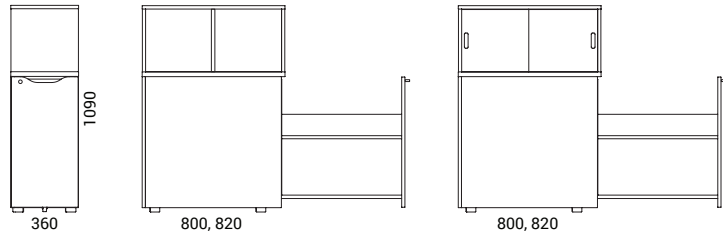
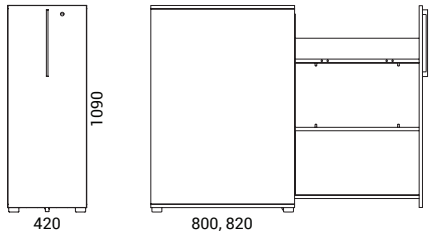
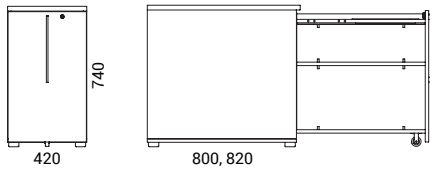

Bookcase

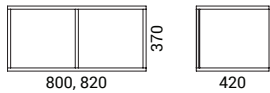

Planter Box

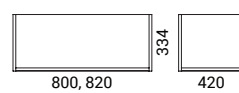

Optional



Drawer's box

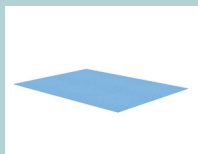

Felt-lined inserts

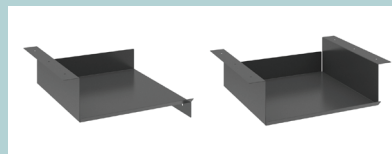

Metal shelves (right / central)



Metal hook for clothes



Master key

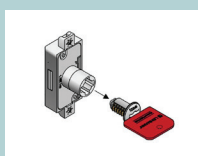

Removal key



Cylinder lock with 2 keys

ADDITIONAL INFORMATION



- Bookcase or plant box fixing. For fixing bookcase or plant box onto the tower please use stickers and follow the assembly scheme (included in the package).



- Planter box care. Please note that the inner part of planter box is not protected from the moisture. We recommend you to use the Melamine Cleaning and Care Instructions.

- Changing tower sides. You can switch the inner wall side from R/H to L/H or vice versa for universal towers - TBU301-302 and towers assembled as R/H or L/H - TBR/TBL201-202, TBR/TBL307-308. Please use the special fittings and follow the assembly scheme (included in the package).

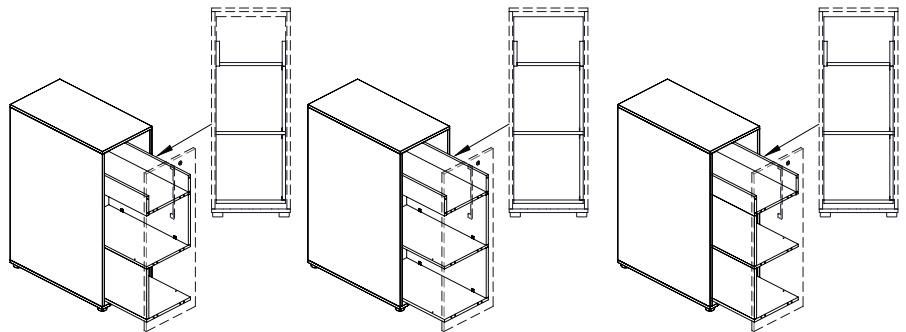

- USB port/power socket cable management.

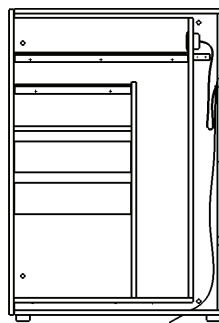

Closed

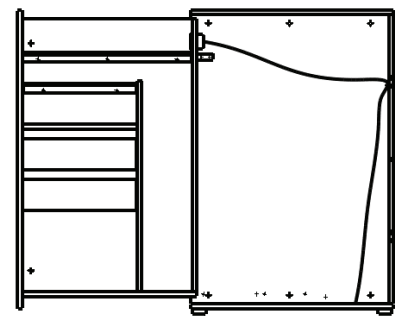

Open

Accessories fixing position

Fixing position of right metal shelf C0Z062



- TBR/TBL201-202



- TBR/TBL301-302 (suitable only for the upper shelf)



- TBU301-302



- TBR/TBL307-308*



- TBR309-310



- TBL309-310

* If you decide to switch sides from right or left, you will have to reassemble the shelves.

Fixing position of central metal shelf C0Z063



- TBR/TBL201-202



- TBU301-302



- TBR/TBL307-308*



- TBR/TBL309-310

* If you decide to switch sides from right or left, you will have to reassemble the shelves.

Fixing position of metal hook ZZZ061



- TBR/TBL311-315

Fixing position of drawer's box ZTZ005



- TBR/TBL201-202

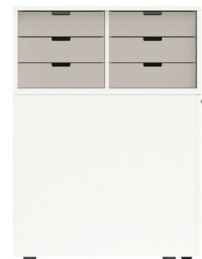

- TBR/TBL302, 304



- TBU301-302